

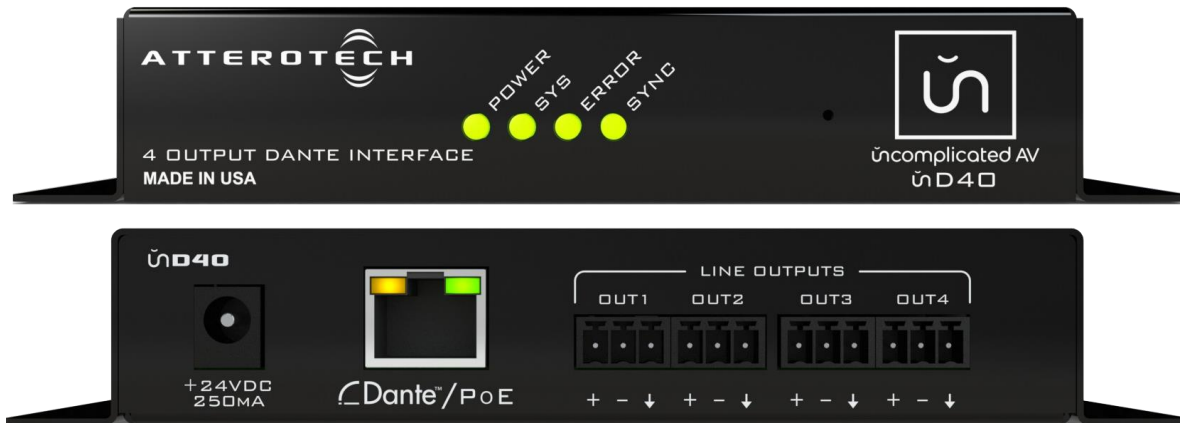

unD40

Four Output Dante™/AES67 Break Out Interface



User Manual

1675 MacArthur Boulevard · Costa Mesa, CA 92626
Ph: 800/854-4079 or 714/957-7100 · Fax: 714/754-6174

© 2020 QSC, LLC all rights reserved. QSC and the QSC logo are registered trademarks of QSC, LLC in the U.S. Patent and Trademark office and other countries. All other trademarks are the property of their respective owners. Patents may apply or be pending.
www.qsc.com

614-00028

IMPORTANT SAFETY INSTRUCTIONS

The symbols below are internationally accepted symbols that warn of potential hazards with electrical products.



This symbol, wherever it appears, alerts you to the presence of un-insulated dangerous voltage inside the enclosure -- voltage that may be sufficient to constitute a risk of shock.



This symbol, wherever it appears, alerts you to important operating and maintenance instructions in the accompanying literature. Please read the manual.

1. Read these instructions.
2. Keep these instructions.
3. Heed all warnings.
4. Follow all instructions.
5. Do not use this apparatus near water.
6. Clean only with a dry cloth.
7. Do not block any ventilation openings. Install in accordance with the manufacturer's instructions.
8. Do not install near any heat sources such as radiators, heat registers, stoves, or other apparatus (including amplifiers) that produce heat.
9. Protect the power cord (Ethernet cable) from being walked on or pinched particularly at plugs, convenience receptacles, and the point where they exit from the apparatus.
10. Only use attachments/accessories specified by Attero Tech
11. Unplug this apparatus during lightning storms.
12. Refer all servicing to qualified service personnel. Servicing is required when the apparatus has been damaged in any way, such as power-supply cord or plug is damaged, liquid has been spilled or objects have fallen into the apparatus, the apparatus has been exposed to rain or moisture, does not operate normally, or has been dropped.
13. If rack mounting, provide adequate ventilation. Equipment may be located above or below this apparatus but some equipment (like large power amplifiers) may cause an unacceptable amount of hum, or may generate too much heat and degrade the performance of this apparatus.



TO REDUCE THE RISK OF FIRE OR ELECTRIC SHOCK, DO NOT EXPOSE THIS APPARATUS TO RAIN OR MOISTURE.

WARRANTY INFORMATION

For a copy of the QSC Limited Warranty, visit the QSC website at www.qsc.com

Note: This equipment has been tested and found to comply with the limits for a Class A digital device, pursuant to Part 15 of the FCC Rules and EN55022. These limits are designed to provide reasonable protection against harmful interference when the equipment is operated in a commercial environment. This equipment generates, uses, and can radiate radio frequency energy and, if not installed and used in accordance with the instruction manual, may cause harmful interference to radio communications. Operation of this equipment in a residential area is likely to cause harmful interference, in which case the user will be required to correct the interference at their own expense



 This symbol means the product must not be discarded as household waste, and should be delivered to an appropriate collection facility for recycling. Proper disposal and recycling helps protect natural resources, human health and the environment. For more information on disposal and recycling of this product, contact your local municipality, disposal service, or the business where you bought this product.





Contents

1 - Overview	4
1.1 - What's in the Box	4
1.2 - Optional Extras	4
1.3 - Device Features	5
1.4 - Mounting and Installation	6
1.5 - Error Reporting	7
1.6 - Status LEDs	7
1.7 - Hardware Connections	8
1.7.1 - Balanced Output to an Unbalanced Input	8
1.7.2 - Balanced Output to a Balanced Input	9
2 - Device Configuration	10
2.1 - IP Address Setup.....	10
ARCHITECTS & ENGINEERING SPECIFICATION	i
Device Specifications	ii

1 – Overview

The unD40 Dante™/AES67 audio interface is a cost effective 4 channel analog break-out box and is designed in a small flange-mount form factor for broad market application. Its size and I/O density make it easy to put Dante™/AES67 connectivity wherever it's needed – on a rack shelf, under a table or near the destination equipment – thereby eliminating costly and interference prone analog wiring and power supplies.

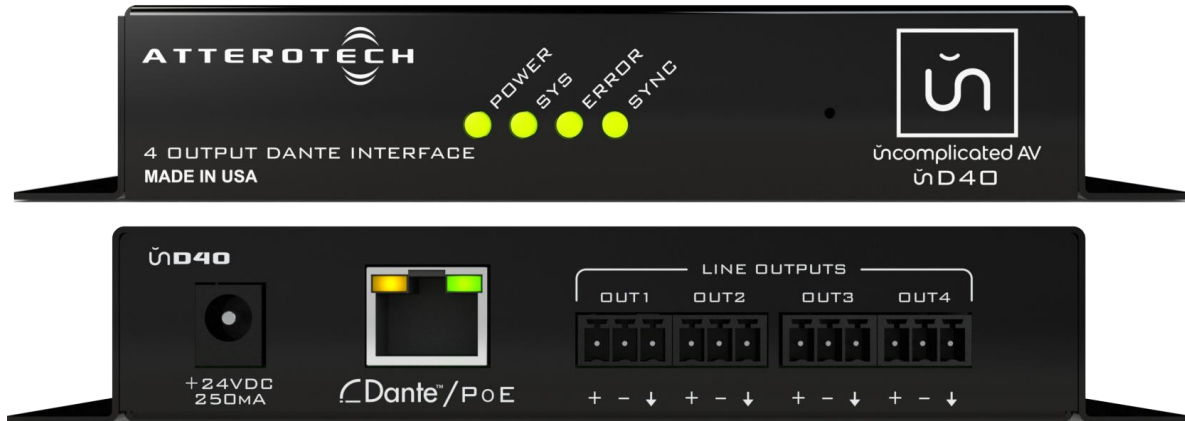

Figure 1 - unD40 Overview

The unD40 features four electronically balanced line-level outputs. All outputs can be used simultaneously and all audio channels are available separately from the Dante network.

Connection to the Dante™/AES67 network is provided by a single Ethernet RJ45 connector on the back of the unit. The unD40 is PoE-enabled which allows the unD40 to be powered over its network cable from a suitable PoE source (IEEE 802.3af) or from a locally connected 24V DC power supply (*sold separately*). This is particularly useful as the unD40 can then be mounted in remote location where access to a mains outlet would be limited or indeed, non-existent.

Audinate's Dante™ Controller or other 3rd party manufacturer's Dante™ routing software can be used to control the audio routing configuration of the device along with enabling of AES67 streams.

1.1 – What's in the Box

The device comes supplied with the following:

- (1) unD40
- (4) 3-position Phoenix plug connectors

1.2 – Optional Extras

The following are available as options for the unD40 and that may be ordered separately:

- 24V DC Power Supply - P/N: 900-00175

1.3 - Device Features

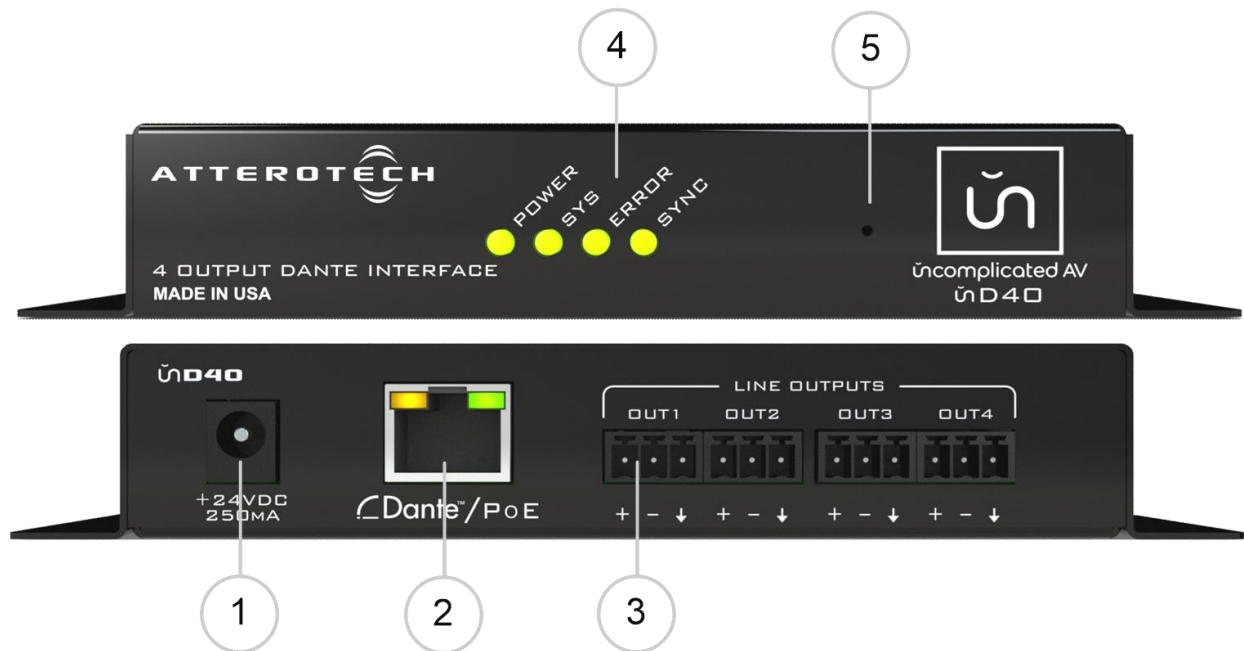

1	24V DC Power Input
2	Dante™/AES67 PoE Connector (requires CAT-5e or better Ethernet cabling)
3	4 x Balanced audio outputs
4	Front Panel LED Status Indicators
5	Recovery reset switch

**Note: The unD40 has a label on the flange of the metal housing that shows the devices MAC address. This is important for initial device identification as the last six digits make up part of the devices default network name that is shown when the device is detected by Dante™ Controller. The full MAC address is also given on the back of the unit.*

1.4 - Mounting and Installation

It is recommended that the unit be secured to a flat surface with a screw through each mounting flange. Dimensions for mounting are shown below. Use a No. 6 screw of a type and size that is applicable to the surface to which the device will be attached.

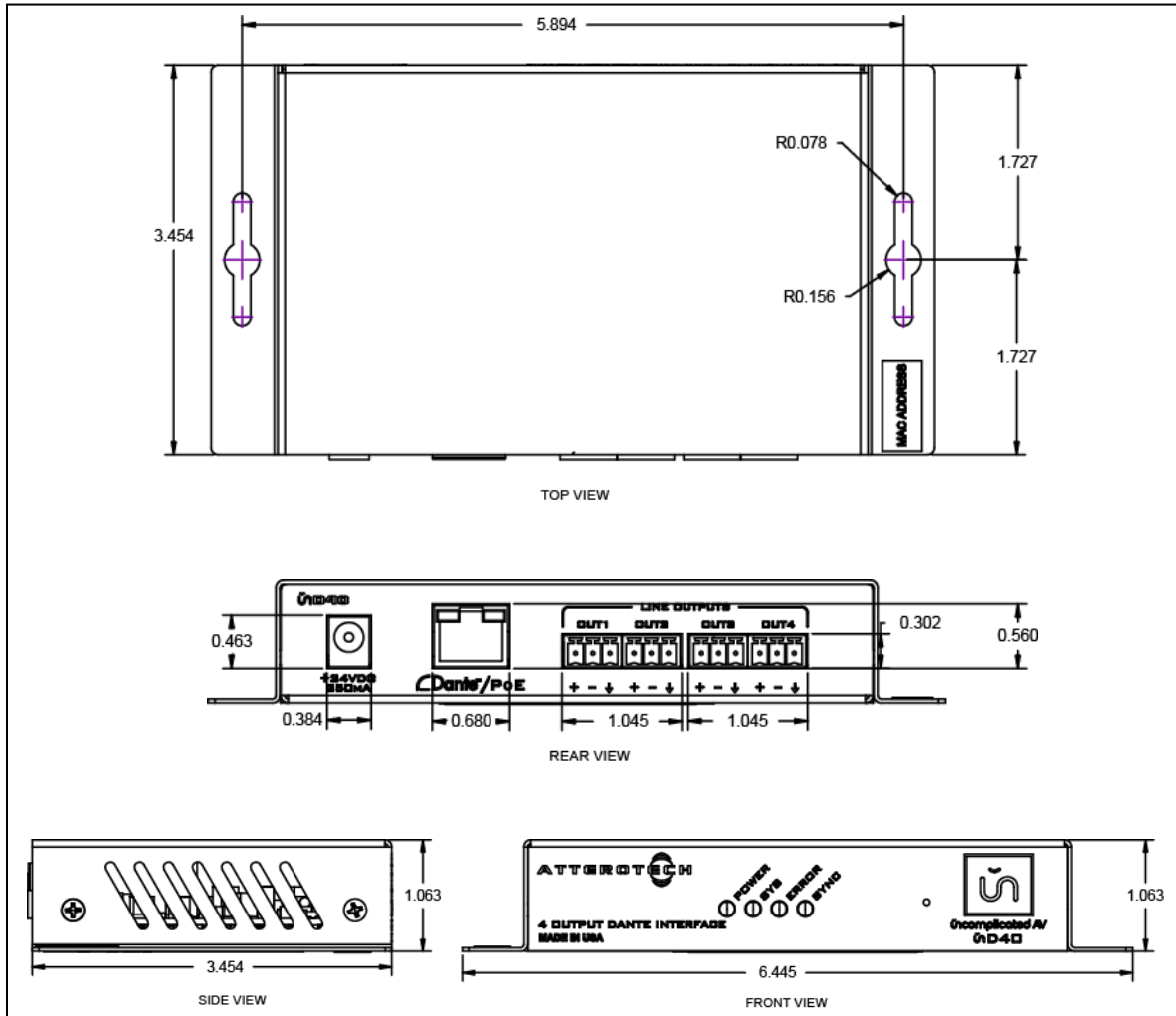

Figure 2 - Mounting Information

- Attach the PoE + Data Dante™/AES67 INTERFACE port to a spare PoE-enabled port on a PoE switch using a CAT-5 cable. If a midspan injector is being used, connect a spare input port to the Dante network switch using a CAT-5 cable, and then connect the corresponding output port to the PoE + Data Dante INTERFACE of the unD40.
- Attach any audio sources that will be used to the inputs. The inputs are balanced so be sure to check what output type the source to be connected uses in order to find how to connect it correctly (see Hardware Connections section).

If all steps are performed correctly, the power LED on the front should be lit. There may also be some activity on the Dante™/AES67 INTERFACE LED indicators. With no Dante™/AES67 network, both LEDs will remain off. If an active connection is made both LEDs will come on and if there is network activity, the yellow LED will then flash.

***Note:** All Attero Tech products are tested using UTP cabling and it is recommended that UTP cabling be used when installing them. STP cabling can be used for installation though care must be taken not introduce grounding issues into the system by doing so.



1.5 – Error Reporting



The unD40 is equipped with error reporting features. Upon power up, the front panel power LED will briefly light red and then change to green if the device boots successfully. If the LED remains on solid red, this indicates a device failure. Additionally, the unD40 has three status indicator LEDs for showing various device states. The following figures show these states and associated descriptions.



1.6 – Status LEDs







The front panel LED's show the Dante™/AES67 diagnostic status. If network or audio problems persist, these LED's may assist in identifying issues.

The LED's are POWER, SYS, ERR and SYNC and the color of each LED has different meanings. The tables below show the combination and what each combination means.

	Color	Description
	Amber	Device Booting - If this LED stays amber, contact support
	Green	Device Booted Successfully

	Color	Description
	Red	Dante™/AES67 Interface booting
	Green	Dante™/AES67 Interface ready

	Color	Description
	Yellow	Capability is corrupted
	Red	Memory stack overflow

	Color	Description
	Amber	PTP currently syncing
	Red	PTP error / no PTP sync / PTP disabled
	Green	PTP Slave, with PTP sync
	Flashing Green	PTP master / Identify*
		Identify (SYS, SYNC and ERRR LED's flashing) (Activated through the Identify function of Dante Controller)

1.7 – Hardware Connections

The unD40 provides balanced audio outputs for connectivity to external analog audio equipment. Refer to the following diagrams and instructions for connecting different types of audio devices to the outputs of the unD40. Professional grade audio cabling is recommended to achieve the best audio performance throughout the system.

1.7.1 – Balanced Output to an Unbalanced Input

Connect the positive terminal of the unD40 output to the signal input or “Tip” of the unbalanced analog input. Connect the unD40 GND connection to the sleeve connection of the unbalanced input.

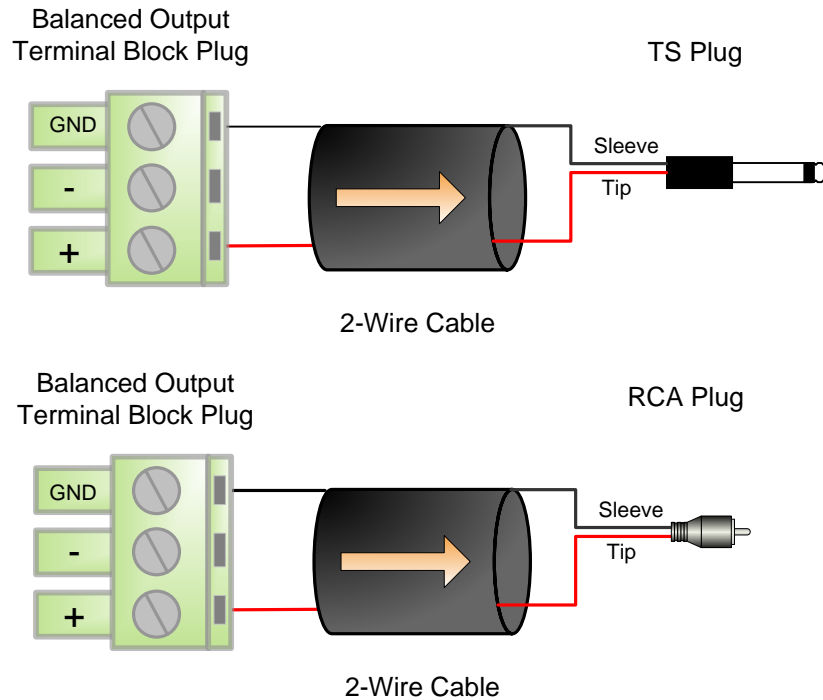

Figure 3 – Unbalanced Wiring Guide

1.7.2 - Balanced Output to a Balanced Input

To connect balanced sources to the unD40, connect the positive output to positive input, negative output to negative input, and connect the grounds together through the cable shield.

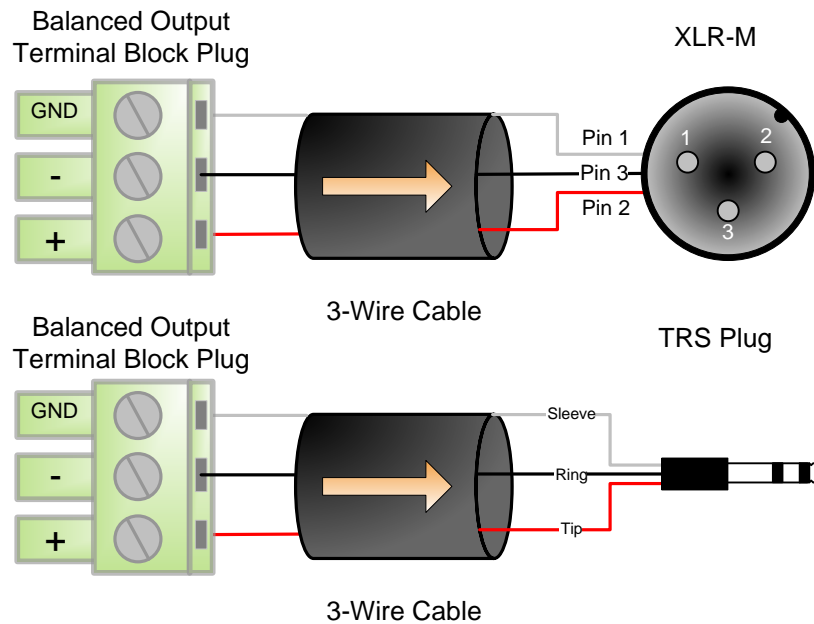

Figure 4 - Balanced Wiring Guide

2 – Device Configuration

The audio routing and enabling of Dante™/AES67 audio streams should be carried out using Audinate’s Dante™ Controller. This can be obtained from the [Audinate website](#). Instructions on how to use this software and about setting up routes on a Dante network can also be found on their website.

**Note: When using Dante™ Controller, the unD4O will be shown using a default device name of “unD4O-#####” where ‘#####’ is the last six characters of the devices MAC address.*

2.1 – IP Address Setup

***** IMPORTANT *****
Failure to correctly configure IP addresses will not allow an unD4O device to show up correctly in Dante™ Controller. The unD4O will appear but its device information won’t be visible. It’s output channels also won’t be visible and routing of audio to the device will not be possible.

In order to configure an unD4O, both to set up internal parameters and also setup audio routing, the PC will need to be able to communicate with the devices over the network. While all Dante™ devices will be discovered regardless of the IP address setup on the PC, communication can only occur if the PC and the device have compatible IP addresses.

By default, the unD4O is set to get a dynamic IP address. As with all Dante™/AES67 devices, if the unD4O does not find a DHCP server to retrieve an IP address from, it will give itself an local link address sometimes also known as an automatic private IP address (APIPA) instead. A local link IP address is always in the range 169.254.x.y.

To ensure communication, the PC can either be set to get a dynamic IP address, or be given a static IP address in the range 169.254.x.y with a subnet mask of 255.255.0.0. The PC may require a restart if its IP address is changed for the change of IP to take effect.

In some applications, IP addresses of devices may need to be set to something specific and that can be done once initial communication has been established. The unD4O does support static IP addresses but bear in mind however that if a static IP address is assigned to a device and that static IP address is in a different range to the IP it was previously using to communicate with the PC, the PC will then lose communication with the device when it’s rebooted until such time as the PC’s IP address is also changed to an IP in range of the devices now new IP address.

Further information on IP setup for an audio system using Dante™ can be found in the [Audinate’s FAQ page](#) on the Audinate website



ARCHITECTS & ENGINEERING SPECIFICATION

The Dante™/AES67 interface unit shall provide four balanced analog outputs on the rear panel via 3-pin depluggable connectors for digital to analog conversion of up to four Dante digital audio network channels.

The internal digital to analog signal conversion shall be performed at 24-bit resolution with a sampling frequency of 44.1kHz, 48kHz, 88.2 kHz or 96 kHz (configured by the system installer via software).

The Dante™/AES67 interface unit shall receive power over the Ethernet cable from an IEEE 802.3af PoE compliant network switch, PoE midspan injector or a locally connected external 24V DC power supply.

The Dante™/AES67 interface shall be compliant with the RoHS, WEEE and REACH directives.

The Dante™/AES67 interface unit shall be Compliant with the EMI/EMC requirements for FCC and CE.

The Dante™/AES67 interface unit shall be the Attero Tech unD40.

Device Specifications

Audio Outputs	
Output Type:	Four balanced line level with automatic muting on loss of Dante signal on 3-pin Depluggable Phoenix
Output Impedance	200 Ohms Balanced
Maximum Output Levels:	+20dBu Balanced
Audio Output Performance	
Dynamic Range:	100 dB
THD+N:	<0.02% @ 1kHz, input signal 3dB below maximum
Frequency Response	20Hz - 20kHz, +/- 1dB

Dante™/AES67 Network	
Physical Level:	Standard Ethernet
Connector:	Single RJ-45
Cable Quality:	CAT-5e or better
Transmission Speed:	100 Mbps
Supported Sample Rates	44.1kHz 48kHz 88.2 kHz 96 kHz
Minimum Dante Network Latency	1 ms
Power Requirements	
PoE	802.3af PoE PD compliant Class 0
Power Consumption	4 W Max.
Cable Quality:	CAT-5e or better
Physical Dimensions	
Width	6.45"
Height	1.06"
Depth	3.45"
Weight	0.8 lbs
Product Compliance	
FCC CFR 47 Parts 15B ICES-003 CE (EN55022) RoHS REACH	