

Core 1000 – Centralized audio and control processor

Core 3000 – Centralized audio and control processor

Core 4000 – Centralized audio and control processor

I/O Frame – Networked audio and control input and output device

Type 2 Hardware

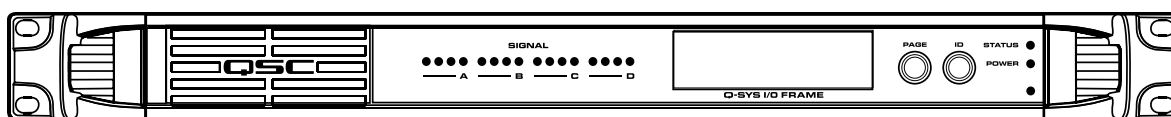
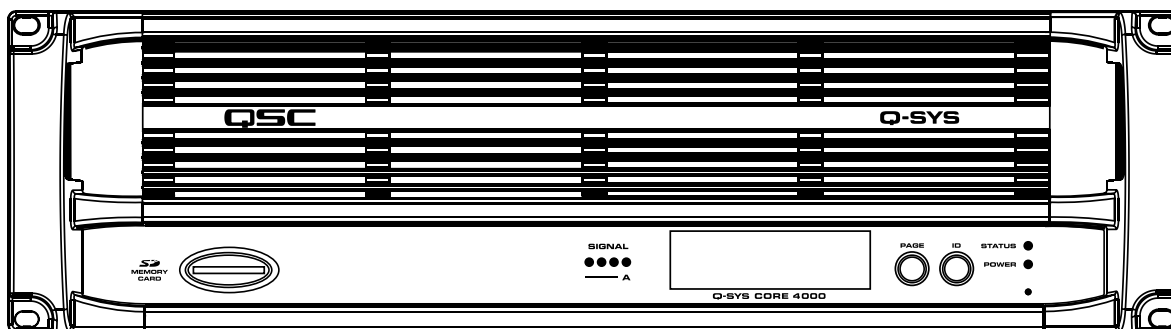
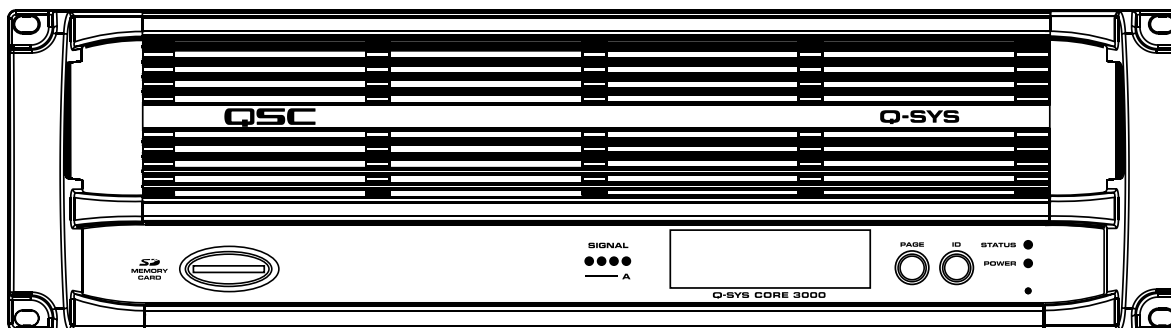
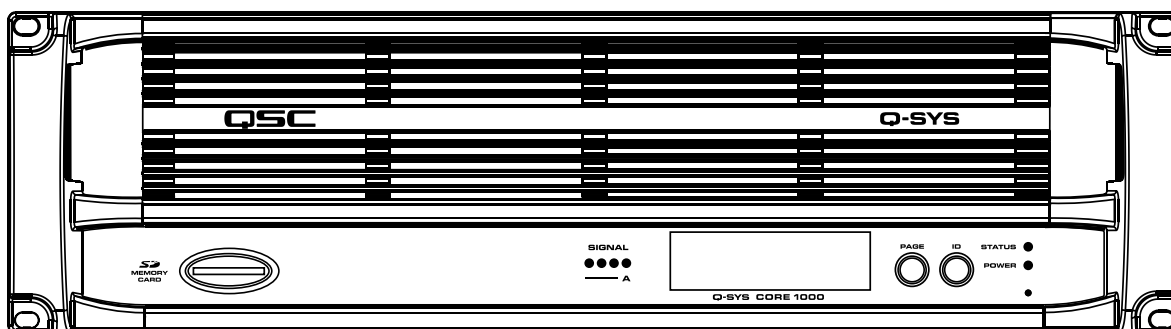

TD-000284-00-A



EXPLANATION OF TERMS AND SYMBOLS

The term "**WARNING!**" indicates instructions regarding personal safety. If the instructions are not followed the result may be bodily injury or death.

The term "**CAUTION!**" indicates instructions regarding possible damage to physical equipment. If these instructions are not followed, it may result in damage to the equipment that may not be covered under the warranty.

The term "**IMPORTANT!**" indicates instructions or information that are vital to the successful completion of the procedure.

The term "**NOTE**" is used to indicate additional useful information.



The intent of the lightning flash with arrowhead symbol in a triangle is to alert the user to the presence of un-insulated "dangerous" voltage within the product's enclosure that may be of sufficient magnitude to constitute a risk of electric shock to humans.



The intent of the exclamation point within an equilateral triangle is to alert the user to the presence of important safety, and operating and maintenance instructions in this manual.



IMPORTANT SAFETY INSTRUCTIONS



WARNING!: TO PREVENT FIRE OR ELECTRIC SHOCK, DO NOT EXPOSE THIS EQUIPMENT TO RAIN OR MOISTURE.

- Maximum operating ambient temperature is 50°C (122°F) for the I/O Frame, 45°C (113°F) for the Core.
- Power requirements are: 100 – 240 VAC, 50 – 60 Hz, and the proper IEC power cord.
- Ensure reliable earth grounding is maintained.
- Distribute the units evenly when installing in a rack. Hazardous conditions can be created by uneven weight distribution.

- Read these instructions.
- Keep these instructions.
- Heed all warnings.
- Follow all instructions.
- Do not use this apparatus near water.
- Clean only with a dry cloth.
- Do not block any ventilation opening. Install in accordance with the manufacturer's instructions.
- Do not install near any heat sources such as radiators, heat registers, stoves, or other apparatus (including amplifiers) that produce heat.
- Do not defeat the safety purpose of the polarized or grounding-type plug. A polarized plug has two blades with one wider than the other. A grounding type plug has two blades and a third grounding prong. The wide blade or the third prong are provided for your safety. If the provided plug does not fit into your outlet, consult an electrician for replacement of the obsolete outlet.
- Protect the power cord from being walked on or pinched particularly at plugs, convenience receptacles, and the point where they exit from the apparatus.
- Only use attachments/accessories specified by the manufacturer.
- Unplug this apparatus during lightning storms or when unused for long periods of time.
- Refer all servicing to qualified service personnel. Servicing is required when the apparatus has been damaged in any way, such as power-supply cord or plug is damaged, liquid has been spilled or objects have fallen into the apparatus, the apparatus has been exposed to rain or moisture, does not operate normally, or has been dropped.
- The AC Mains plug is the AC mains disconnect device and shall remain readily accessible after installation.
- Adhere to all applicable, local codes.
- Consult a licensed, professional engineer when any doubt or questions arise regarding a physical equipment installation.

LITHIUM BATTERY WARNING

THIS EQUIPMENT MAY CONTAIN A NON-RECHARGEABLE LITHIUM BATTERY. LITHIUM IS A CHEMICAL KNOWN TO THE STATE OF CALIFORNIA TO CAUSE CANCER OR BIRTH DEFECTS. THE NON-RECHARGEABLE LITHIUM BATTERY CONTAINED IN THIS EQUIPMENT MAY EXPLODE IF IT IS EXPOSED TO FIRE OR EXTREME HEAT. DO NOT SHORT CIRCUIT THE BATTERY. DO NOT ATTEMPT TO RECHARGE THE NON-RECHARGEABLE LITHIUM BATTERY.

FCC Statement



NOTE: This equipment has been tested and found to comply with the limits for a Class B digital device, pursuant to Part 15 of the FCC Rules.

These limits are designed to provide reasonable protection against harmful interference in a residential installation. This equipment generates, uses and can radiate radio frequency energy and, if not installed and used in accordance with the instructions, may cause harmful interference to radio communications. However, there is no guarantee that interference will not occur in a particular installation. If this equipment does cause harmful interference to radio or television reception, which can be determined by turning the equipment off and on, the user is encouraged to try to correct the interference by one or more of the following measures:

- Reorient or relocate the receiving antenna.
- Increase the separation between the equipment and receiver.
- Connect the equipment into an outlet on a circuit different from that to which the receiver is connected.
- Consult the dealer or an experienced radio/TV technician for help.

Warranty (USA only; other countries, see your dealer or distributor)

Disclaimer

QSC Audio Products, LLC ("QSC") is not liable for any damage to amplifiers, loudspeakers, or any other equipment that is caused by negligence or improper installation and/or use of this signal processing product. While QSC has endeavored to develop and produce the most dependable and robust network audio product for your use, due to the myriad of network situations and equipment that may be encountered in its implementation, QSC cannot be held responsible for network conflicts and associated consequences that may result. For this reason, QSC strongly recommends that the network used for implementation of Q-Sys products be completely separate from all other networks, data or otherwise. As such, should you elect to integrate Q-Sys products with your existing network system, all risks attendant to such integration of Q-Sys products with your existing network or network systems are assumed by you. While QSC strives to provide the highest quality technical solutions for networked audio products, in no event will QSC or its suppliers be held liable for any damages, consequential, incidental or otherwise, including any claims for lost profits and/or savings resulting from any attempted integration of Q-Sys products with your networking systems. No agent, employee or representative of QSC has any authority to alter or modify in any manner, the disclosures and recommendations set forth herein.

QSC Audio Products 3 Year Limited Warranty

QSC Audio Products, LLC ("QSC") guarantees its products to be free from defective material and/or workmanship and will replace defective parts and repair malfunctioning products under this warranty when the defect occurs under normal installation and use, provided the unit is returned to our factory, one of our authorized service stations or an authorized QSC International Distributor via pre-paid transportation with a copy of proof of purchase (i.e., sales receipt). This warranty provides that the examination of the return product must indicate, in our judgment, a manufacturing defect. This warranty does not extend to any product which has been subjected to misuse, neglect, accident, improper installation, or where the date code has been removed or defaced. QSC shall not be liable for incidental and/or consequential damages. This warranty gives you specific legal rights. This limited warranty is freely transferable during the term of the warranty period. The warranty on QSC products is NOT VALID if the products have been purchased from an unauthorized dealer/online e-tailer, or if the original factory serial number has been removed, defaced, or replaced in any way. Damage to, or loss of any software or data residing on the product is not covered. When providing repair or replacement service, QSC will use reasonable efforts to reinstall the product's original software configuration and subsequent update releases, but will not provide any recovery or transfer of software or data contained on the serviced unit not originally included in the product.

Customers may have additional rights, which vary from state to state or from country to country. In the event that a provision of this limited warranty is void, prohibited or superseded by local laws, the remaining provisions shall remain in effect.

The QSC limited warranty is valid for a period of three (3) years from date of purchase in the United States and many (but not all) other countries.

For QSC warranty information in countries other than the United States, contact your authorized QSC international distributor. A list of QSC International distributors is available at www.qscaudio.com.

To register your QSC product online, go to www.qscaudio.com and select "Product Registration". Other questions regarding this warranty can be answered by calling, e-mailing or contacting your authorized QSC distributor.

Phone: 1-800-854-4079 within US and Canada, +1-714-754-6175 international, **Email:** warranty@qscaudio.com, **Website:** www.qscaudio.com.

RoHS Statement

The following chart is provided for product use in China.

		Q-Sys™ Core 系列, Q-Sys I/O Frame				
部件名称 (Part Name)	有毒有害物质或元素 (Toxic or hazardous Substances and Elements)					
	铅 (Pb)	汞 (Hg)	镉 (Cd)	六价铬 (Cr(vi))	多溴联苯 (PBB)	多溴二苯醚 (PBDE)
电路板组件 (PCB Assemblies)	X	0	0	0	0	0
机壳装配件 (Chassis Assemblies)	0	0	X	0	0	0

0: 表明这些有毒或有害物质在部件使用的同类材料中的含量是在 SJ/T11363_2006极限的要求之下。
 0: Indicates that this toxic or hazardous substance contained in all of the homogeneous materials for this part is below the limit requirement in SJ/T11363-2006.

X: 表明这些有毒或有害物质在部件使用的同类材料中至少有一种而含量是在SJ/T11363_2006极限的要求之上。
 X: Indicates that this toxic or hazardous substance contained in at least one of the homogeneous materials used for this part is above the limit requirement in SJ/T11363-2006.

Unpacking

There are no special unpacking precautions. However, it is recommended that you keep the original packing materials for reuse in the rare event that service is required. If service is required and the original packing material is not available, ensure that the unit is adequately protected for shipment (use a strong box of appropriate size, sufficient packing/padding material to prevent load shifting or impact damage) or call QSC's Technical Services Group for replacement packing material and a carton.

What is included in your Q-Sys™ product carton:

- Q-Sys Core 1000, Core 3000, Core 4000 or Q-Sys I/O Frame product
- Rubber feet
- Hardware Manual
- Q-Sys Designer software CD (Core 1000, Core 3000 and Core 4000 products only)
- IEC power cord and cord lock wire
- Connector plug kit appropriate for the optional Q-Sys Audio I/O Card(s) ordered

Mounting

Q-Sys products can be used in or out of an equipment rack. Rack mounting is optional. Adhesive rubber feet are included for non-rack mount installations (table or shelf top installations). Use the feet to prevent the unit from scratching or marring the support surface.

Rack Mount Instructions

Rack mount the Q-Sys product by supporting it from underneath while aligning the front panel mounting holes (in the rack ears) with the threaded screw holes in the rack rails. Install all four mounting screws and washers and tighten securely. All Q-Sys products come with rear rack support ears. Ensure that these rear mounting points are securely fastened to rear rack rails or side walls.



WARNING! Reliable Earthing – Reliable earthing of rack-mounted equipment should be maintained. Particular attention should be given to supply connections other than direct connections to the branch circuit (e.g. use of power strips).

Mechanical Loading – Mounting of the equipment in the rack should be such that a hazardous condition is not achieved due to uneven or unstable mechanical loading.



CAUTION!: Elevated Operating Ambient - If installed in a closed or multi-unit rack assembly, the ambient operating temperature of the rack environment may be greater than room ambient. Consideration should be given to ensure that the maximum operating temperature of 50°C (122°F) for the I/O Frame, and 45°C (113°F) for the Core, is not exceeded.

Reduced Air Flow – Installation of the equipment in a rack should be such that the amount of air flow required for safe operation of the equipment is not compromised.

Circuit Overloading – Consideration should be given to the connection of the equipment to the supply circuit and the effect that overloading of the circuits might have on over-current protection and supply wiring.

Connections

AC Power Cord

Insert the molded receptacle of the AC power cord into the AC power inlet on the back of the Q-Sys product. Plug the AC line connector into an AC outlet. The power supply on the Q-Sys Core and I/O frame accepts 100 – 240 V, 50 – 60 Hz. If a different type of IEC power cord is required than that supplied with the product, consult QSC’s Technical Services Group.

Q-Sys™ Network

Connect one end of a data communications cable (CAT-6 rating or better) terminated with an RJ45 plug into the LAN A (and optionally LAN B) receptacle on the rear panel of the Q-Sys product. Ensure that the lock tab on the cable engages with the RJ45 receptacle. (Figure 1)

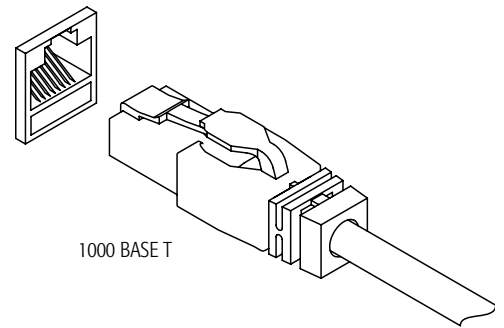

– Figure 1 –

Mic/Line Inputs, Line Outputs, AES3 I/O

Several of the optional audio I/O Cards accept Euro style (also known as Phoenix) three-terminal plugs. (Figure 2) When these cards are ordered in the product configuration a shop kit containing the mating plugs is included in the carton contents. Plug the Euro terminal block plug into the appropriate input or output receptacle on the Q-Sys Audio I/O Card’s panel face. The connection pinout is printed on the Q-Sys Audio I/O Card mounting bracket. Refer to the illustrations in the right-hand column of this page for balanced and unbalanced connections (analog connections only – AES3 connections always require all three conductors).

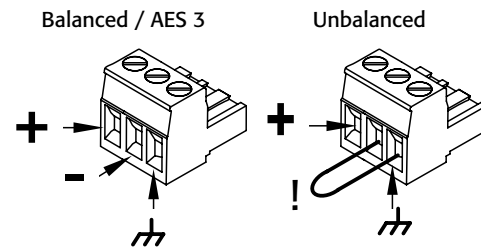

– Figure 2 –

DataPorts

The Q-Sys DataPort I/O Card is intended to interface to QSC amplifiers with v1 DataPorts. This is the all-capable version 1 DataPort specification, supported on CX, DCA, PowerLight™, PL2, and PL3 Series amplifiers. All DataPorts use the HD15 connector format and connect to QSC amplifiers via data communications cables having male HD15 connectors. (Figure 3)

These appear to be common VGA cables but they are not. Many off-the-shelf VGA cables MIGHT work with satisfactory results, however it is also quite possible off-the-shelf cables will give less-than-satisfactory results, and could even cause damage to QSC amplifiers! The QSC DataPort specification requires that all conductors be present, as well as shielding over those conductor pairs used for the audio channels to the amplifier. Therefore, QSC recommends the use of QSC DataPort cables exclusively, which are available in a variety of lengths from QSC. Use of any non-QSC DataPort cable may void the warranty.

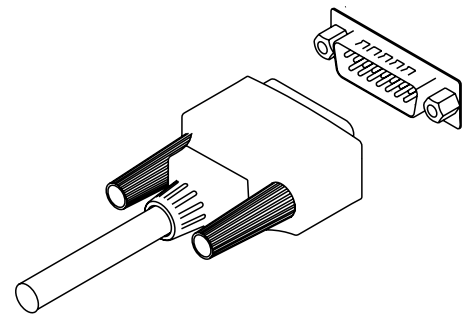

– Figure 3 –

To connect a DataPort cable between a Q-Sys DataPort I/O Card and an amplifier DataPort, attach the cable’s male connectors to the HD15 ports and finger tighten the thumb screws on the connector. (Figure 3)

Minimum System Requirements for Q-Sys™ Designer

Q-Sys Designer is the software you use to create the designs for a Q-Sys system. After your system is designed, tested and deployed on the Core, Q-Sys designer is not required for that system to operate. Q-Sys Designer runs in a PC environment with the following minimum requirements.

Software

- Microsoft® Windows® 7
- Microsoft® Windows Vista® SP1
- Microsoft® Windows XP® Professional Version 2002 SP3
- Microsoft® .NET Framework 3.5 SP1

PC Hardware Requirements for Windows Vista Home Premium / Business / Ultimate

- 1 GHz 32-bit (x86) or 64-bit (x64) processor
- 1 GB of system memory
- 40 GB hard drive with at least 15 GB of available space
- Support for DirectX 9 graphics with:
 - a. WDDM Driver
 - b. 128 MB of graphics memory (minimum)
 - c. Pixel Shader 2.0 in hardware
 - d. 32 bits per pixel
- CD-ROM or DVD drive
- Keyboard and Microsoft® Mouse or compatible pointing device

PC Hardware Requirements for Windows XP Professional

- PC with 300 megahertz or higher processor clock speed recommended; 233 MHz minimum required (single or dual processor system); Intel® Pentium®/Celeron® family, or AMD K6®/AMD Athlon®/AMD Duron® family, or compatible processor recommended.
- 128 megabytes (MB) of RAM or higher recommended (64 MB minimum supported; may limit performance and some features)
- 1.5 gigabytes (GB) of available hard disk space
- Super VGA (800 x 600) or higher-resolution video adapter and monitor
- CD-ROM or DVD drive
- Keyboard and Microsoft® Mouse or compatible pointing device

Installing Q-Sys Designer

1. Start your PC.
2. Close any running applications.
3. If you have an internet connection, you can download the latest software at www.qscaudio.com/products/software/QSys or place the Q-Sys Designer CD into your CD-ROM/DVD drive.
4. The software should auto-run. If not, select run from the start menu. Browse to the file named setup.exe on your CD-ROM/DVD drive
5. Click the Install Q-Sys Designer button.
6. Follow the on-screen prompts/instructions.

Quick Start Guide

This is intended to give a high-level procedure for getting a simple Q-Sys system connected, running a Q-Sys design, and passing audio. The following procedure assumes that you have a Q-Sys Designer file with components properly connected, but not necessarily configured.

1. Set up network. For more information about Network Requirements see Help File Networking Topic; for a list of qualified switches see “Qualified Ethernet Switches” on page 13.
2. Connect PC, Core and I/O Frame to the network.
3. Connect DataPort amplifiers and loudspeakers.
4. Power up the equipment.
5. On the PC, Start Q-Sys Designer.
 - a. Open your design file.
 - b. Select the Core in the Inventory list, and verify the configuration.
 - c. Open Q-Sys Configurator and select the Core with the same name as in the design. If the names are different, you must change the hardware name or the name of the Core component in Q-Sys Designer so they match.
 - » A new Core is shipped with both LANs enabled, and the addressing Mode set to Auto.
 - » Auto - If there is a DHCP server on the network, the IP Address is automatically assigned.
 - » Static – You assign a static IP Address, Mask and Default Gateway.
 - » Off – LAN B only, no network redundancy
 - d. Select the I/O Frame in the Inventory list, and verify the configuration.
 - e. In Q-Sys Configurator, Select the I/O Frame with the same name as in the design. If the names are different, you must change the hardware name or the name of the I/O Frame component in Q-Sys Designer so they match.
 - » A new I/O Frame is shipped with both LANs enabled, and the addressing Mode set to Auto.
 - » Auto - If there is a DHCP server on the network, the IP Address is automatically assigned.
 - » Static – You assign a static IP Address, Mask and Default Gateway.
 - » Off – LAN B only, no network redundancy
 - f. Ensure that the amplifiers are properly connected in the design and configured correctly. The connections and configuration should match the physical connections.
 - g. Ensure that the loudspeakers are properly connected to the amplifiers in the design, and configured correctly. The connections and configuration should match the physical connections.
 - h. There are many ways to pass audio through the Q-Sys system, your design should contain one or more ways to do this. If not, refer to the Online Help and add one of the components that would allow you to pass audio.
 - i. Save the design to the Core and connect (Press F5).
 - j. If the Core’s firmware does not match that of Q-Sys Designer on your PC, you are prompted to update the firmware.



NOTE: To download the latest Q-Sys Designer software and firmware, go to <http://www.qscaudio.com/products/software/QSys>.

6. Test the system.

Before trying to pass audio, place the System Mute component in your design, Run the design (F5), and click the Mute button. When you attempt to pass audio for the first time, you can un-mute the system and the output will ramp up to the level of the settings in your design. If the system begins to get too loud, you can press the mute button again and make necessary adjustments. Introduction

Overview

Q-Sys™ is an integrated system audio solution. The DSP is centralized to allow faster development and deployment of new features, and requires fewer hardware changes as well. Q-Sys has been designed around four major criteria: Sonic Quality, Reliability, Power and Flexibility.

Type 2 Hardware

With this release of Q-Sys hardware, new IDC (ribbon type) connectors have replaced the FCC (flex type) connectors installed in earlier releases of hardware. Due to this change, the Type 2 hardware is not physically compatible with the older hardware. You can still integrate the new I/O Frames and Cores in the same system with older hardware, but the I/O cards are not interchangeable. Type 2 hardware can be identified by a yellow label (Figure 4) on the back of the Core and I/O Frame, and the bottom of the I/O cards.

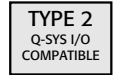

– Figure 4 –

Components

Q-Sys is comprised of the following dedicated components:

- **Q-Sys Core** (Required) – The Core is the central processing unit of Q-Sys. The Core processes and routes all audio, controls peripheral devices, manages firmware updates to the peripheral devices, all via a gigabit Ethernet network. The Core has one slot available to add one of the I/O cards listed under Q-Sys I/O Frame below.
- **Q-Sys I/O Frame** (Recommended) – The I/O Frame is the link between the input/output devices and the Core. The I/O Frame converts analog audio input signals to digital and passes them over the network to the Core. It also receives the processed digital audio signal from the Core, converts it to analog and sends it to the output devices. The I/O Frame houses one or more of the following:
 - DataPort Card (Optional) – provides audio, telemetry, and control interface between Q-Sys and QSC DataPort amplifiers and QSC loudspeakers.
 - Standard (Std) or High Performance (HP) Mic/Line Input Card (Optional) – provides the interface between input devices (microphones, CD/DVD players, mixers, and so on) and Q-Sys.
 - Line Out Card (Optional) – provides the interface between third-party amplifiers, recording devices, other devices and Q-Sys.
 - AES Card (Optional) – provides the interface between digital devices such as mixing consoles, recording devices, other devices and Q-Sys.
 - Blank Card (Optional) – fills card slot when no card is needed.
- **Q-Sys Designer Software** (Required for designing, not required for operation) – Q-Sys Designer is the design software application that creates the design file that is loaded onto a Q-Sys Core. The design file contains all the virtual components, their connections and initial DSP settings. The design is initially created on a PC running Q-Sys Designer. When the design is complete, it is loaded on the Core and tested, and adjustments made. When all adjustments are finalized, the design is saved to the Core. Q-Sys Designer is not required to operate the Q-Sys system. Q-Sys Designer requires a Windows-based PC running Windows XP or Windows Vista.
- **Gigabit Ethernet Network** (Required) – The Q-Sys solution is designed around a high performance network implementation called Q-LAN that offers gigabit data rates, device and network redundancy, 32-bit floating point audio data transfers, end node discovery and low-latency support on local area network deployments. Additionally, Q-LAN offers long-haul IP streaming of audio over wide area network deployments. Accurate synchronization of end nodes and high-quality clock distribution are built-in to the solution using the IEEE-1588 Precision Time Protocol. All devices are connected to a managed 1000 Mbps Ethernet switch with appropriate QoS (Quality of Service) enabled suitable for a high-performance gigabit network. For switch recommendations see Page 12.
 - 1 Gigabit Ethernet
 - Latency – 0.66 ms across network
 - 32-bit floating point format
 - Redundancy (Optional)
 - 1 to 16 channels per audio stream (managed by the Core)
 - 1.65 to 3.31 Mb bandwidth per channel (dependent on the number of channels per stream)
- **Q-Sys DataPort Amplifier Backup Panel • DAB-801** (Optional) – Provides N+1 Amplifier redundancy
- **Q-Sys Touch Screen Controllers** (Optional) – Provides End-User touch-screen, wall-mounted control
 - Power over Ethernet
 - Touch-Panel Interface
 - Design Control Pages in Q-Sys Designer
 - Core is the server for the saved Control Pages
 - Built-in Navigation and Security Integrated System

Q-Sys is an integrated system designed to work with QSC DataPort amplifiers and QSC loudspeakers and other QSC products to provide system-level telemetry and control. Q-Sys can also be configured with generic amplifiers and/or generic loudspeakers, but there is a loss of functionality when not using QSC compatible hardware.

QSC DataPort Amplifiers

QSC DataPort amplifiers (PowerLight™, CX, PL2, DCA, and PL3) can be used in a Q-Sys system to communicate with the Q-Sys DataPort card and provides critical telemetry information and protection for both the amplifier and any QSC loudspeaker. Generic amplifiers can be used in a Q-Sys system by connecting the amplifier to a Line Out connection; however, there is no telemetry or control of either the amplifier or loudspeakers (even QSC loudspeakers) if Line Out cards are used.

Loudspeakers

Q-Sys, QSC DataPort amplifiers, and QSC loudspeakers work together to form an integrated system that provides specific loudspeaker processing (Intrinsic Correction™), telemetry, and protection for the loudspeaker. You can use generic loudspeakers in a Q-Sys system, however there is no Intrinsic Correction provided.

Redundancy

Q-Sys is capable of several redundant configurations to ensure a high level of overall system reliability.

- **2N Core redundancy** – Two Cores, primary and redundant, communicating with each other and peripherals to verify system health, and to synchronize control settings.
- **2N Network redundancy** – Two separate networks - In this configuration, you can have each Q-Sys Core and/or I/O Frame connected to both networks.
- **2N I/O redundancy** – For each I/O Frame, you can have a backup I/O Frame.
- **N+1 Amplifier redundancy** – One amplifier can back up from one to eight amplifiers with the Q-Sys DAB-801 (DataPort Amplifier Backup).

Network Redundancy

Both the Core and the I/O Frame have two network ports, LAN A (primary), and LAN B (backup). The LAN B port on I/O Frame becomes active when it is configured in Q-Sys Designer as “Is Network Redundant” and connected. Because the I/O Frame is configured in the design file, the Core recognizes it as being on LAN B as well as LAN A. During operation, the Core routes audio and control signals to both ports, so if LAN A, or a part of LAN A fails, the Core switches to LAN B with no failover time.

Q-Sys Hardware Redundancy

The Core and I/O Frame can have backups connected to the network. Both are identified in Q-Sys Designer as being redundant. The backup Core communicates with the primary to ensure it is up to date with any changes made on the primary, and to monitor the primary Core’s health. The Core monitors the I/O Frames, if there is a problem detected with the primary I/O Frame, the Core switches to the backup. The audio inputs and outputs of the primary and backup I/O Frames are wired in parallel, meaning that the audio source drives two inputs. The audio outputs of an offline I/O Frame are disconnected by relays, so only the active I/O Frame, in a redundant pair, drives the outputs.

Q-Sys™ Core 1000 | Core 3000 | Core 4000 Panel Features

Figure 5 and Figure 6 show the Q-Sys Core front and rear panel features for a product having a simple configuration of one blank I/O Card slot.



NOTE: The Q-Sys hardware products are configured at the QSC factory per your order. At the time of order, you specify the type of Q-Sys Audio I/O Card to be installed in the Audio I/O bay on the Q-Sys Core. In addition, Q-Sys Audio I/O Card Kits are available for field installation by qualified service personnel.

Front Panel

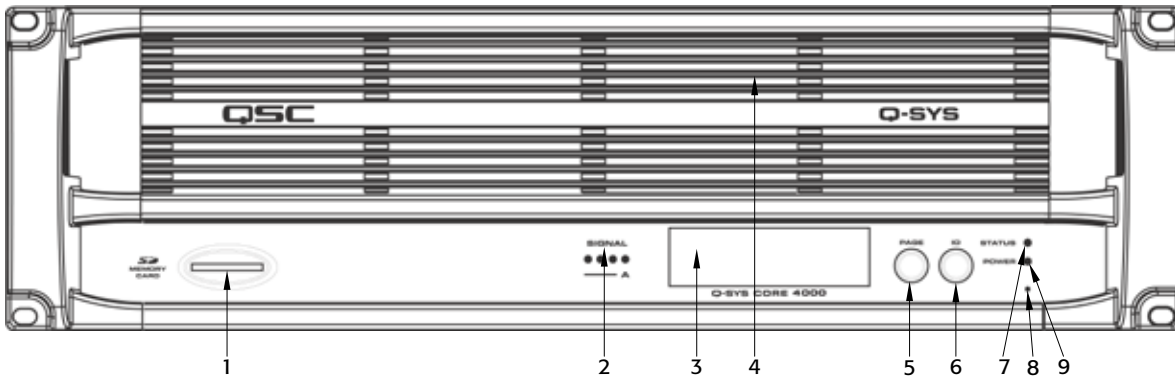

– Figure 5 –

- | | |
|--|--|
| <ol style="list-style-type: none"> 1. SD Card Reader Socket 2. Audio I/O Signal and Card Present Indicators 3. 240 x 64 Monochrome Graphics LCD 4. Exhaust Vents 5. Next Page Navigation Button | <ol style="list-style-type: none"> 6. Device ID Button (locates device in Q-Sys Designer GUI) 7. Status LED (reports network health, ID and firmware update status) 8. Power On LED 9. Clear Settings Paperclip Button (resets network properties) |
|--|--|

Rear Panel

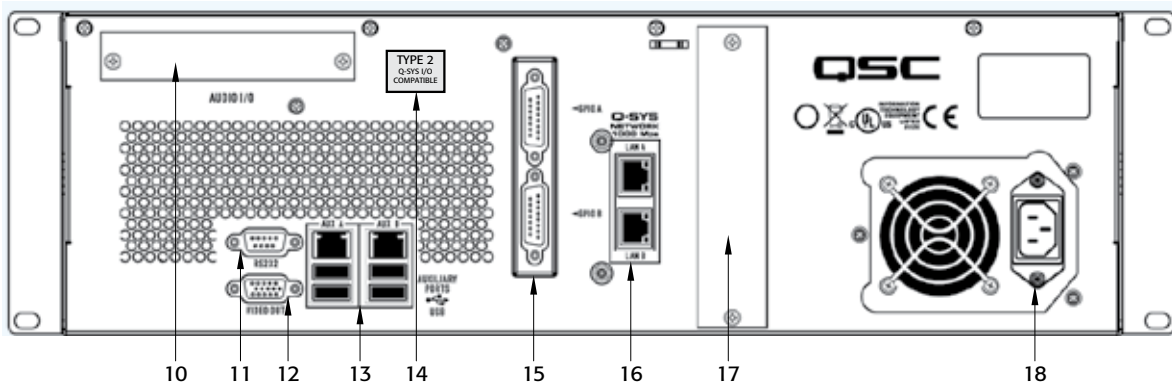

– Figure 6 –

- | | |
|---|---|
| <ol style="list-style-type: none"> 10. Audio I/O Bay – accepts optional Q-Sys audio I/O cards 11. RS-232 – DE-9 male connector for serial communications 12. Video Out – HD-15 female connector accepts diagnostic VGA monitor 13. Auxiliary Ports <ul style="list-style-type: none"> AUX A Set – USB host connector x2, RJ45 10/100/1000 Mbps Ethernet AUX B Set – USB host connector x2, RJ45 10/100/1000 Mbps Ethernet 14. Type 2 Hardware Label | <ol style="list-style-type: none"> 15. GPIO A and GPIO B – female DA-15 connectors for Q-Sys control I/O 16. Q-Sys Network Port <ul style="list-style-type: none"> LAN A – 1000 Mbps only, primary connection to Q-Sys gigabit network LAN B – 1000 Mbps only, backup connection to Q-Sys gigabit network 17. Reserved for Future Use 18. AC Main Inlet – IEC male connector |
|---|---|

Q-Sys™ I/O Frame Panel Features

Figure 7 and Figure 8 show the Q-Sys I/O Frame front and rear panel features for a product having a sample configuration of two Mic/Line Input Cards and two DataPort I/O Cards.



NOTE: The Q-Sys hardware products are configured at the QSC factory per your order. At the time of order, the you specifies the type of Q-Sys Audio I/O Card to be installed in each of the four rear panel audio I/O bays on the Q-Sys I/O Frame. In addition, Q-Sys Audio I/O Card Kits are available for field installation by qualified service personnel.

Front Panel

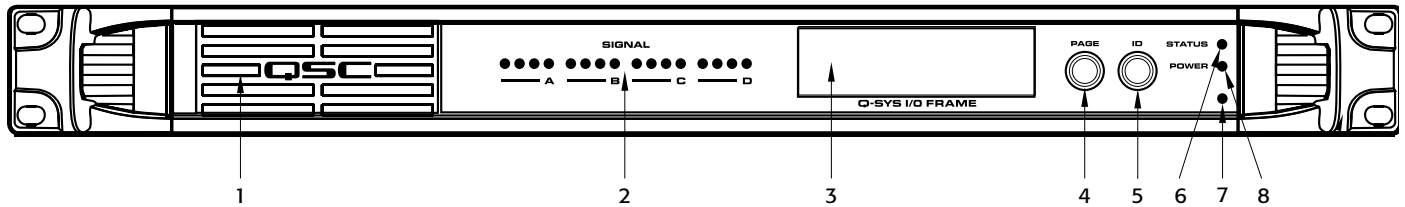

– Figure 7 –

- | | |
|--|---|
| <ul style="list-style-type: none"> 1. Fan Exhaust Vents 2. Audio I/O Signal and Card Present Indicators 3. 240 x 64 Monochrome Graphics LCD 4. Next Page Navigation Button | <ul style="list-style-type: none"> 5. Device ID Button (locates device in GUI) 6. Reset Network Properties Paperclip Button 7. Status LED (reports network health, ID and firmware update status) 8. Power On LED |
|--|---|

Rear Panel

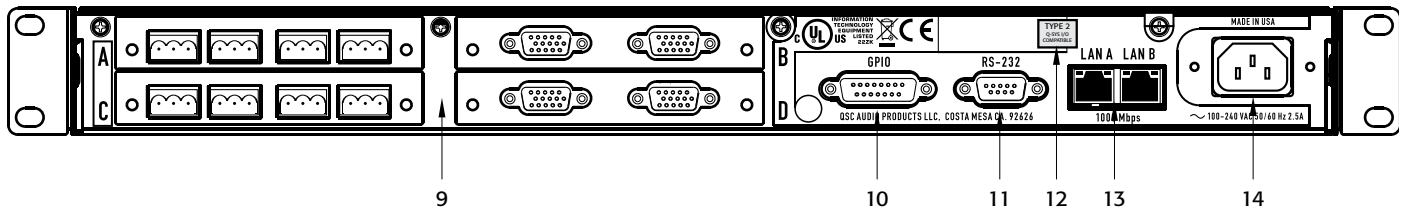

– Figure 8 –

- | | |
|---|---|
| <ul style="list-style-type: none"> 9. Configurable Audio I/O Bays 10. GPIO Interface (control I/O) (see Page 12) 11. RS-232 Serial Control Interface | <ul style="list-style-type: none"> 12. Type 2 Hardware Label 13. Dual Gigabit Network Interfaces for Q-Sys LANs 14. AC Main Inlet – IEC male connector |
|---|---|

Q-Sys™ I/O Card Remove and Replace Procedure

This procedure is for Q-Sys Type 2 I/O Cards only. Card installation should only be done by a trained and qualified technician.

Tools

Refer to Figure 9

- Phillips screwdriver
- ESD grounded wrist strap
- 1/4" hex driver/socket (not shown) for replacing Q-Sys I/O Cards in positions C or D.



CAUTION! An ESD grounded wrist strap must be worn throughout the remove and replace procedure. The end of the wrist strap should be connected to an unpainted surface on the product chassis such as the ground stud.

1. Disconnect the AC mains power cord from the Q-Sys I/O Frame.
2. Connect and put on the ESD grounded wrist strap.
3. Remove the sheet metal screws securing the lid to the Q-Sys I/O Frame chassis. Remove the lid by lifting it approximately 1" at the rear of the chassis while sliding it back from the front.



NOTE: To remove an I/O Card in position C or D, you must first remove the appropriate card above it in position A or B. The following steps apply to both top and bottom cards.

4. Locate the I/O Card to be replaced and, except for the Blank Card, remove the ribbon cable from the card by gently pushing outward on the cable ejector tabs. (Figure 10) The connector should be free of the socket.
5. Remove the two screws securing the I/O Card mounting bracket to the rear of the chassis. Remove the bracket. (Figure 11)
6. Remove the I/O Cards:
 - a. For cards in positions A or B, remove the four Phillips head screws securing the card to the standoffs. Remove the card. If you are not replacing a card in position C or D, skip to step 7.
 - b. For cards in positions C or D, perform step 6.a, then remove the four hex standoffs securing the lower card, and remove the card.
7. Install the new I/O Card by reversing steps 5 and 6. Be sure to align and secure the rear panel mounting bracket before tightening the hex standoffs or card-securing screws. **If you are replacing a card in positions C or D, complete step 8 now, and then install the upper card and repeat step 8 for the upper card.**
8. Reconnect the ribbon cable to the I/O Card, by aligning the tab on the cable connector housing with the key on the card connector as shown in Figure 12. Gently push down on the cable connector housing to seat the cable into the card connector. When properly seated, the cable ejectors will lock in place with the thumb tabs upright.
9. When replacing the Blank Card with an I/O Card, the new ribbon cable must also be attached to the I/O Frame main board. To do this, locate the main board audio connectors (Figure 13), Then locate the appropriate card position indicator on the main board for the card being replaced (A, B, C or D). Attach the ribbon cable in the same manner as the I/O Card, ensuring that the cable connector tab is aligned with the main board connector key and that the cable is properly seated with the ejector tabs in their locked position.
10. Replace the I/O Frame lid and secure the sheet metal screws.



– Figure 9 –

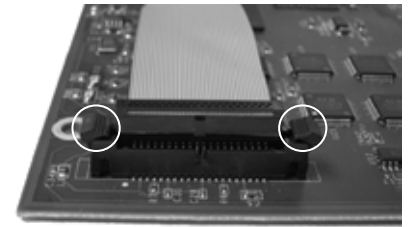

– Figure 10 –



– Figure 11 –

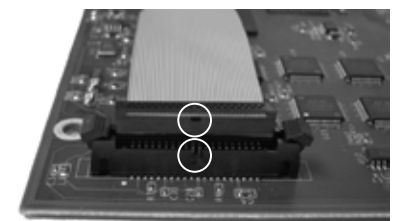

– Figure 12 –



– Figure 13 –

Qualified Ethernet Switches

Q-Sys uses layer 3 (DSCP) QoS. This type of QoS is deployed differently on different networks and therefore requires user intervention to set up properly. Because of this complexity, switches which are not managed are not acceptable for Q-Sys. For more details about network and switch setup, refer to the Help File in Q-Sys Designer. For more details about the following switches, refer to the manufacturers' website. The following switches have been tested and qualify for use with a Q-Sys™ network.



NOTE: Refer to the Q-Sys Online help on the QSC website for the latest list of switches.
(<http://www.qscaudio.com/products/software/QSys/WebHelp/>)

Linksys®	HP® ProCurve™	Cisco®	
SLM Series Smart Switches (EOL)	3500 Series	Catalyst 3560E Series	Small Business 300 Series
SLM2005	3500yl-24G-PWR	3560E-24TD	SG-300-10
SLM2008	3500yl-24G-PoE+	3560E-24PD	SG-300-10P
SLM2024	3500yl-48G-PWR	3560E-48PD	SG-300-10MP
SLM2048	3500yl-48G-PoE+	3560E-48TD	SG-300-20
SRW Series Managed Switches (EOL)	5406zl (all modules)	3560E-48PD-F	SG-300-28
SRW2008	5412zl (all modules)	3560E-12D	SG-300-28P
SRW2008MP	6200yl-24G-mGBIC	3560E-12SD	SG-300-52
SRW2008P		Catalyst 3750 Series	
SRW2016		3750E-24TD	
SRW2024		3750E-24PD	
SRW2024P		3750E-48TD	
SRW2048		3750E-48PD	
		3750E-48PD-F	

Q-Sys™ GPIO Signal Specifications

GPIO Pin Assignments

DB15 Pin	Signal Name	Signal Type	Description
1	RNO	Relay Contact	Relay - normally open
2	RNC	Relay Contact	Relay - normally closed
3	GPIO1	Normal Current	GPIO pin
4	GPIO3	Normal Current	GPIO pin
5	POWER	Power	+12 V DC
6	GPIO5	High Current	GPIO pin - high current capable
7	GPIO7	High Current	GPIO pin - high current capable
8	GND	Ground	Ground
9	RC	Relay Contact	Relay - common
10	GND	Ground	Ground
11	GPIO2	Normal Current	GPIO pin
12	GPIO4	Normal Current	GPIO pin
13	POWER	Power	+12 V DC
14	GPIO6	High Current	GPIO pin - high current capable
15	GPIO8	High Current	GPIO pin - high current capable

GPIO Specifications

Relay Pins	Normal Current Pins	High Current Pins
Maximum Voltage, relative to Ground: 30 V	Maximum Input Range: 0 V to 32 V	Maximum Input Range: 0 V to 32 V
Maximum Current through Relay: 1 Amp	Analog Input Range: 0 V to 24 V	Analog Input Range: 0 V to 24 V
		Digital Input, Low: 0.8 V maximum
		Digital Input, High: 2.0 V minimum
Power Pins		Digital Output, Low: 0.4 V maximum
Output Voltage: 11V min, 13V max		Digital Output, High: 2.4 V minimum, 3.3 V maximum
Maximum Output Current: 400 mA		Digital Output Impedance: 1k ohm
		High Current Output, Low: 0.4 V maximum
		High Current Output, High: 11 V minimum, 13 V maximum
		High Current Output, sink or source: 280 mA



NOTE: The maximum current sourced by one GPIO connector (including both High Current and Power Pins) is 400 mA.

Specifications

Type 2 System Hardware

	Core 1000 Core 3000 Core 4000	I/O Frame
Description	System processor and control engine	System audio input and output device
Front Panel Controls	LCD page forward momentary switch Unit ID button momentary switch Clear settings momentary switch	LCD page forward momentary switch Unit ID button momentary switch Clear settings momentary switch
Front Panel Card Receptacle	SD (secure digital) standard size media	–
Front Panel Indicators	Power On: Blue LED Device Status: Tri-color LED Audio Signal: Five tri-color LEDs 240 x 64 monochrome LCD graphics display	Power On: Blue LED Device Status: Tri-color LED Audio Signal: Five tri-color LEDs/per I/O card slot 240 x 64 monochrome LCD graphics display
Rear Panel Connectors	RS-232: DE-9 (male 9-pin D shell connector) Video Out: HD-15 (female 15-pin D shell connector) Aux ports AUX A set: USB host x2, RJ45 10/100/1000 MBps Aux ports AUX B set: USB host x2, RJ45 10/100/1000 MBps GPIO A: DA-15 (female 15-pin D shell connector) GPIO B: DA-15 (female 15-pin D shell connector) Q-Sys Network LAN A: RJ45 1000 MBps only Q-Sys Network LAN B: RJ45 1000 MBps only	RS-232: DE-9 (male 9-pin D shell connector) GPIO A: DA-15 (female 15-pin D shell connector) Q-Sys Network LAN A: RJ45 1000 MBps only Q-Sys Network LAN B: RJ45 1000 MBps only
Maximum Ambient Operating Temperature	45°C (113°F)	50°C (122°F)
Capacity		
Network Audio Channels In	64 128 128 – 512 ¹ 128 – 512 ¹	–
Network Audio Channels Out	64 128 2048	–
Maximum Channels Out ²	1024 2048	–
End Node Capacity	128 256 512	–
Processing (Channels of 32-bit audio)	128 256 512	–
I/O Capacity	Up to 4 channels. Requires purchase of I/O cards	Up to 16 channels ³ . Requires purchase of I/O cards.
Line Voltage Requirements	100 VAC – 240 VAC, 50 – 60 Hz	100 VAC – 240 VAC, 50 – 60 Hz
Dimensions (HWD)	5.25" x 19" x 15" (133.35 mm x 482.6 mm x 381 mm)	1.75" x 19" x 15" (44.45 mm x 482.6 mm x 381 mm)
Accessories Included	6 ft UL/CSA/IEC line cord • User Manual • Software CD • Optional audio I/O ship kit	6 ft UL/CSA/IEC line cord • User Manual • Optional audio I/O ship kit

- 1 Up to 512 network audio channels when sending 8 or more channels per network audio stream.
- 2 Using maximum fan-out with 16-channel unidirectional I/O Frames.
- 3 The CAES4 card (AES-3 input/output) doubles the audio channel count of any slot in which it is used.

I/O Cards

	Mic/Line Input CIML4	High-Performance Mic/Line Input CIML4-HP	Line Output COL4	DataPort Output CODP4	AES-3 Input/Output CAES4
Description	Four channels of microphone / line-level analog audio input with 48V phantom power	Four channels of microphone / line-level analog audio input with 48V phantom power and high performance pre-amplifiers and A/D converters	Four channels of balanced, line-level analog output	Four audio output channels (2 DataPorts) for connection to DataPort equipped QSC amplifiers	Four input and four output channels of AES-3 digital audio
Performance					
Dynamic Range Unweighted	> 105 dB	> 112 dB	> 112 dB	> 114 dB	–
Dynamic Range A-weighted	> 108 dB	> 115 dB	> 115 dB	> 117 dB	–
Distortion 20 Hz – 20 kHz +4 dBu (nominal input)	< 0.009% THD+N	< 0.004% THD+N	–	–	–
Distortion 20 Hz – 20 kHz 2 dB below clip (max)	< 0.08% THD+N	< 0.06% THD+N	< 0.004% THD+N	< 0.004% THD+N	–
Crosstalk 20 Hz – 20 kHz					
Inter-channel (max)	> 100 dB	> 110 dB	> 100 dB	> 95 dB	–
Inter-channel (typ)	> 110 dB	> 110 dB	> 110 dB	> 100 dB	–
Intra-channel (max)	> 100 dB	> 110 dB	> 100 dB	> 100 dB	–
Intra-channel (typ)	> 110 dB	> 110 dB	> 110 dB	> 110 dB	–
Frequency Response 20 Hz – 20 kHz (max)	± 0.5 dB	± 0.5 dB	± 0.5 dB	± 0.5 dB	–
Frequency Response 20 Hz – 20 kHz (typ)	± 0.2 dB	± 0.2 dB	± 0.2 dB	± 0.2 dB	± 0.2 dB
Input Impedance					
Balanced (nominal)	10 k ohms	10 k ohms	–	–	–
Unbalanced (nominal)	10 k ohms	10 k ohms	–	–	–
Common Mode Rejection 20 Hz – 20 kHz (max)	> 45 dB	> 45 dB	–	–	–
Common Mode Rejection 20 Hz – 20 kHz (typ)	> 50 dB	> 50 dB	–	–	–
Max Input Level	0.123, 2.25, 8.70, 17.35 Vrms -16, 10, 21, 27 dBu -18.2, 7.04, 18.8, 24.78 dBv (4 selections)	1.23 to 17.35 Vrms -56 to 27 dBu -58.2 to 24.8 dBv (continuously variable)	– – –	– – –	– – –
Mute	Infinite attenuation (via digital mute)	Infinite attenuation (via digital mute)	Infinite attenuation (via electro-mechanical relays)	Infinite attenuation (via electro-mechanical relays)	Infinite attenuation (via digital mute)
Audio Converters					
Analog to Digital Conversion (ADCs)	24-bit delta-sigma at 48 or 96 kHz sample rate	24-bit delta-sigma at 48 or 96 kHz sample rate	–	–	–
Digital to Analog Conversion (DACs)	–	–	24-bit delta-sigma at 48 or 96 kHz sample rate	24-bit delta-sigma at 48 or 96 kHz sample rate	–
Group Delay	< 13 FS (≈ 271 μs) at 48 kHz	< 13 FS (≈ 271 μs) at 48 kHz	< 10 FS (≈ 196 μs) at 48 kHz	< 13 FS (≈ 271 μs) at 48 kHz	< 37 FS (≈ 760 μs) at 48 kHz ⁴
Connectors	Four 3-terminal Euro-style detachable terminal blocks	Four 3-terminal Euro-style detachable terminal blocks	Four 3-terminal Euro-style detachable terminal blocks	Two 15-pin HD15 connectors	Four 3-terminal Euro-style detachable terminal blocks

	Mic/Line Input CIML4	High-Performance Mic/Line Input CIML4-HP	Line Output COL4	DataPort Output CODP4	AES-3 Input/Output CAES4
User-configurable Options (software enabled)					
Phantom Power	+48 V phantom power (meets IEC 1938 [1996] spec)	+48 V phantom power (meets IEC 1938 [1996] spec)	–	–	–
Output Trim	–	–	8.7V	–	–
Vrms (max)	–	–	21 dBu	–	–
dBu (max)	–	–	18.8 dBv	–	–
dBv (max)	–	–	–	–	–
Amplifier Standby	–	–	–	Set or clear amplifier in standby mode	–
Mute	–	–	–	Set or clear individual channel mutes	–
Enable Meters	–	–	–	Enable data collection of meters for each channel	–
Audio Output Levels	–	–	–	Adjust individual audio channel levels	–
Amplifier Model Support	–	–	–	CX, PowerLight™ 3 Series, DCA, and legacy V1 models	–

4 Group Delay assumes that the sample rate converter is enabled.

CobraNet I/O Card

CobraNet Input/Output CCN32

Description	Up to 32 input and 32 output channels of CobraNet digital audio
Performance	
Dynamic Range A-weighted	> 138 dB
Frequency Response 20 Hz – 20 kHz	± 0.2 dB
THD+N	-130 dB (typ)
Group Delay	Selectable: modeRate = 0x400: 1.479 ms (2.812 ms w/SRC enabled) modeRate = 0x500: 2.813 ms (4.146 ms w/SRC enabled) modeRate = 0x600: 5.479 ms (6.812 ms w/SRC enabled)
I/O Capacity	Selectable: 4 x 4 8 x 8 16 x 16 32 x 32 (Core only)
Bundle Packing	0 to 8 channels
CobraNet Network Transmitters	4
CobraNet Network Receivers	4
Configuration Management	Simple Network Management Protocol v1
Mute	Infinite attenuation (via digital mute)
Connectors	Two RJ-45 jacks



NOTE: Specifications subject to change without notice.



QSC Audio Products, LLC

1675 MacArthur Boulevard

Costa Mesa, CA 92626-1468 USA

Main Number: 714-754-6175

Sales & Marketing: 714-957-7100 or toll free (USA only) 800-854-4079

Sales & Marketing FAX: 714-754-6174

Customer Service FAX: 714-754-6173

qscaudio.com

info@qscaudio.com

service@qscaudio.com

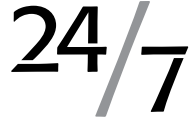

Q-Sys™ Customer Support

Q-Sys Technical Support

QSC offers 24/7 support on Q-Sys networked audio systems only

USA and Americas

Full Support Business hours: 6 AM to 5 PM Pacific time (Mon-Fri)

Emergency only After-Hours and Weekend support*

USA: 1-800-772-2834

Non-USA: +1 714-957-7150

Asia & India

Full Support Business hours: 8 AM to 6 PM WITA time (UTC +8) (Mon-Fri) Emergency only After-Hours and Weekend support*

Tel: +852-3-973-3832

Europe & Middle East

Full Support Business hours: 8 AM to 6 PM CET time (Mon-Fri) Emergency only After-Hours and Weekend support*

Tel: +32 28-080467

* After hours calls are guaranteed a 30 minute response time when calls are not directly answered by a QSC support engineer.

© 2011 QSC Audio Products, LLC. The QSC logo, QSC and Q-Sys are registered trademarks of QSC Audio Products, LLC and are registered with the US Patent and Trademark office. US and Worldwide Patents Pending. Q-Sys and Intrinsic Correction are trademarks of QSC Audio Products, LLC. AMD is a trademark of Advanced Micro Devices, Inc. Cisco is a trademark of Cisco Systems, Inc. HP and ProCurve are trademarks of Hewlett Packard Development Company. Linksys is a trademark of Cisco Systems, Inc. CobraNet is a trademark of Cirrus Logic. Microsoft trademarks are owned by Microsoft Corp. in the US and other countries. All other trademarks are the property of their respective owners. Patents pending.