

DPA-Q & DPA-QN Q-SYS Network Amplifiers



User Manual

DPA 2K4Q — 4 Channel, 2000 W Network Amplifier with Mic/Line Inputs

DPA 4K4Q — 4 Channel, 4000 W Network Amplifier with Mic/Line Inputs

DPA 8K4Q — 4 Channel, 8000 W Network Amplifier with Mic/Line Inputs

DPA 4K8Q — 8 Channel, 4000 W Network Amplifier with Mic/Line Inputs

DPA 8K8Q — 8 Channel, 8000 W Network Amplifier with Mic/Line Inputs

DPA 2K4QN — 4 Channel, 2000 W Network Amplifier

DPA 4K4QN — 4 Channel, 4000 W Network Amplifier

DPA 8K4QN — 4 Channel, 8000 W Network Amplifier

DPA 4K8QN — 8 Channel, 4000 W Network Amplifier

DPA 8K8QN — 8 Channel, 8000 W Network Amplifier

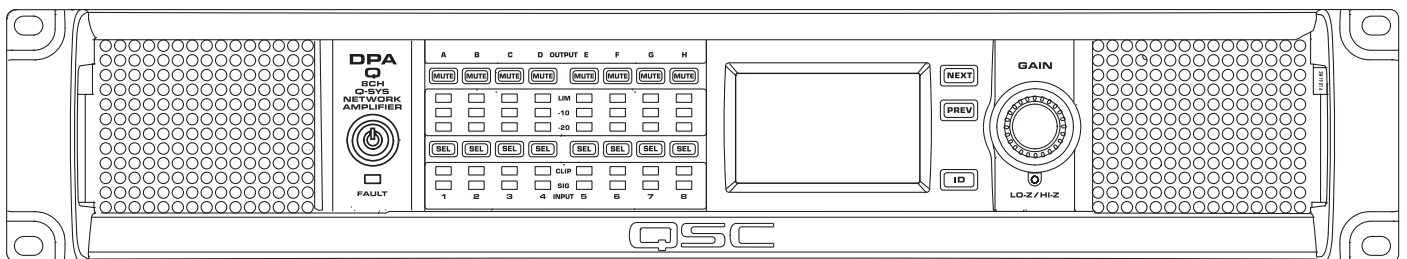

TD-001585-01-B



EXPLANATION OF SYMBOLS

The term **“WARNING!”** indicates instructions regarding personal safety. If the instructions are not followed the result may be bodily injury or death.

The term **“CAUTION!”** indicates instructions regarding possible damage to physical equipment. If these instructions are not followed, it may result in damage to the equipment that may not be covered under the warranty.

The term **“IMPORTANT!”** indicates instructions or information that are vital to the successful completion of the procedure.

The term **"NOTE"** is used to indicate additional useful information.



The intent of the lightning flash with arrowhead symbol in a triangle is to alert the user to the presence of un-insulated "dangerous" voltage within the product's enclosure that may be of sufficient magnitude to constitute a risk of electric shock to humans.



The intent of the exclamation point within an equilateral triangle is to alert the user to the presence of important safety, and operating and maintenance instructions in this manual.



IMPORTANT SAFETY INSTRUCTIONS



WARNING! TO REDUCE THE RISK OF FIRE OR ELECTRIC SHOCK, DO NOT EXPOSE THIS EQUIPMENT TO RAIN OR MOISTURE. Elevated Operating Ambient – If installed in a closed or multi-unit rack assembly, the ambient operating temperature of the rack environment may be greater than room ambient. Consideration should be given to ensure that the maximum operating temperature range -10°C to 50°C (14°F to 122°F) is not exceeded. Reduced Air Flow – Installation of the equipment in a rack should be such that the amount of air flow required for safe operation of the equipment is not compromised.

1. Read these instructions.
2. Keep these instructions.
3. Heed all warnings.
4. Follow all instructions.
5. Do not use this apparatus near water.
6. Clean only with a dry cloth.
7. Do not block any ventilation opening. Install in accordance with the manufacturer's instructions.
8. Do not install near any heat sources such as radiators, heat registers, stoves, or other apparatus that produce heat.
9. To reduce the risk of electrical shock, the power cord shall be connected to a mains socket outlet with a protective earthing connection.
10. Do not defeat the safety purpose of the polarized or grounding-type plug. A polarized plug has two blades with one wider than the other. A grounding type plug has two blades and a third grounding prong. The wide blade or the third prong are provided for your safety. If the provided plug does not fit into your outlet, consult an electrician for replacement of the obsolete outlet.
11. Protect the power cord from being walked on or pinched particularly at plugs, convenience receptacles, and the point where they exit from the apparatus.
12. Only use attachments/accessories specified by the manufacturer.
13. Unplug this apparatus during lightning storms or when unused for long periods of time.
14. Refer all servicing to qualified service personnel. Servicing is required when the apparatus has been damaged in any way, such as power-supply cord or plug is damaged, liquid has been spilled or objects have fallen into the apparatus, the apparatus has been exposed to rain or moisture, does not operate normally, or has been dropped.
15. The appliance coupler, or the AC Mains plug, is the AC mains disconnect device and shall remain readily operable after installation.
16. Adhere to all applicable, local codes.
17. Consult a licensed, professional engineer when any doubt or questions arise regarding a physical equipment installation.
18. Do not use any aerosol spray, cleaner, disinfectant or fumigant on, near or into the apparatus. Clean only with a dry cloth.
19. Do not unplug the unit by pulling on the cord, use the plug.
20. Do not submerge the apparatus in water or liquids.
21. Keep ventilation opening free of dust or other matter.

Maintenance and Repair



WARNING! Advanced technology, e.g., the use of modern materials and powerful electronics, requires specially adapted maintenance and repair methods. To avoid a danger of subsequent damage to the apparatus, injuries to persons and/or the creation of additional safety hazards, all maintenance or repair work on the apparatus should be performed only by a QSC authorized service station or an authorized QSC International Distributor. QSC is not responsible for any injury, harm or related damages arising from any failure of the customer, owner or user of the apparatus to facilitate those repairs. In the event of malfunction, contact QSC Customer Support for assistance.

FCC Statement



NOTE: This equipment has been tested and found to comply with the limits for a Class B digital device, pursuant to Part 15 of the FCC Rules.

These limits are designed to provide reasonable protection against harmful interference in a residential installation. This equipment generates, uses and can radiate radio frequency energy and, if not installed and used in accordance with the instructions, may cause harmful interference to radio communications. However, there is no guarantee that interference will not occur in a particular installation. If this equipment does cause harmful interference to radio or television reception, which can be determined by turning the equipment off and on, the user is encouraged to try to correct the interference by one or more of the following measures:

- Reorient or relocate the receiving antenna.
- Increase the separation between the equipment and receiver.
- Connect the equipment into an outlet on a circuit different from that to which the receiver is connected.
- Consult the dealer or an experienced radio/TV technician for help.

Environmental

Life cycle 10 years / Storage temperature -20 ° C to + 70 ° C / Relative humidity 5 - 85% RH

Service life - 10 years. Storage conditions: temperature from -20 ° C to + 70 ° C, humidity 5% - 85%.

If you wish to discard electronic equipment, please contact your dealer or supplier for further information.

RoHS Statement



The QSC DPA-Q and DPA-Qn Series Amplifiers are in compliance with “China RoHS” directives. The following chart is provided for product use in China and its territories:

QSC DPA-Q and DPA-Qn Series Amplifiers						
有毒有害物质或元素 (Toxic or hazardous Substances and Elements)						
部件名称 (Part Name)	铅 (Pb)	汞 (Hg)	镉 (Cd)	六价铬 (Cr(vi))	多溴联苯 (PBB)	多溴二苯醚 (PBDE)
电路板组件 (PCB Assemblies)	X	0	0	0	0	0
机壳装配件 (Chassis Assemblies)	X	0	0	0	0	0

0: 表明这些有毒或有害物质在部件使用的同类材料中的含量是在 SJ/T11363_2006 极限的要求之下。
(0: Indicates that this toxic or hazardous substance contained in all of the homogeneous materials for this part is below the limit requirement in SJ/T11363_2006.)

X: 表明这些有毒或有害物质在部件使用的同类材料中至少有一种含量是在 SJ/T11363_2006 极限的要求之上。
(X: Indicates that this toxic or hazardous substance contained in at least one of the homogeneous materials used for this part is above the limit requirement in SJ/T11363_2006.)





海拔和热带条件

	仅适用于海拔2000m 以下地区安全使用	Only suitable for safe use in areas below 2000m above sea level
	仅适用于非热带气候条件下地区安全使用	Only suitable for safe use in non-tropical climates

Warranty

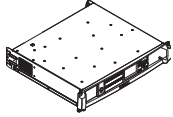
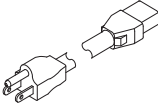
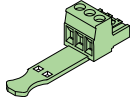
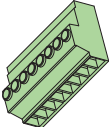
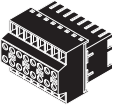
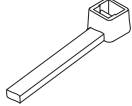
For a copy of the QSC Limited Warranty, visit the QSC website at www.qsc.com

What's in the Box

 (1x) DPA-Q or DPA-QN Amplifier	 (1x) AC Cord	 (8x or 4x) DPA-Q Inputs (3-Pins)	 (2x or 1x) Outputs (8-Pins)	 (1x) GPIO (16-pins)
 (16x or 8x) DPA-Q Cable Tie	 (1x) Warranty	 (1x) Safety Information	 (1x) Quick Start Guide	

Features

Amplifier Front Panel

Refer to "Amplifier Controls and Indicators" on page 11.

Amplifier Rear Panel

Refer to Figure 1



WARNING! Dangerous voltage possible on output terminals. Disconnect AC Mains before connecting or disconnecting output wiring.



NOTE: The DPA-QN models do not have the analog inputs (Item 2a / 2b below).

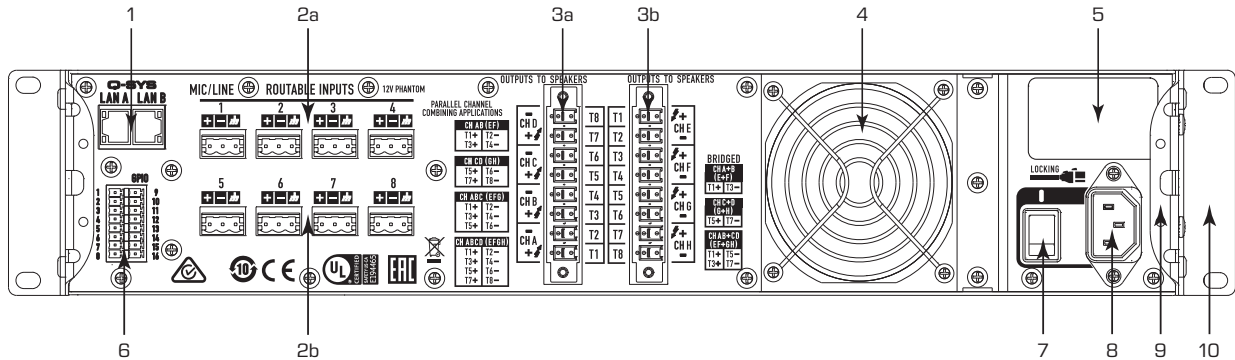

— Figure 1 — DPA-Q 8-Channel Model Shown

1. RJ-45 – Q-SYS Q-LAN A / B
2. Analog Inputs – Mic or Line level, 12V Phantom power, 3-pin Euro-style Connectors
 - a. Inputs 1-4 All DPA-Q Models
 - b. Inputs 5-8 Models: DPA 4K8Q, DPA 8K8Q
3. Outputs – Loudspeaker Connector, 8-pin Euro-style
 - a. Outputs A–D All Models
 - b. Outputs E–H 8-Channel Models only
4. Cooling fan inlet (do not block)
5. Product information:
 - a. Serial Number with manufacturer date code: Refer to Figure 7
 - b. Country of origin, "Product of China".
6. GPIO Euro-style Connector, 16-pin
7. AC Power Switch
8. Locking IEC Power Connection
9. Rear Rack-mount Brackets
10. Front Rack-mount Brackets

— Table 1 — Serial Number / Date Code Translation

Z	WWW	YY	XXXX	Sequential	4-digit base-29 (0-9, A-Z (excluding A,E,I,O,U,D,S), beginning with 0001 and reset at the beginning of each work week.
				Year	2-digit calendar year (17 = 2017)
				Work Week	2-digit calendar week number
				N/A	Not used for manufacturer date

Installation

The following steps are written in the recommended installation order.

Rack-Mount the Amplifier

The DPA Series amplifiers are designed to be mounted in a standard rack-mount unit. The amplifiers are 2RU high, and 381 mm (15 in) deep.

1. Secure the amplifier in the rack with eight screws (not supplied), four in front, four in back. For complete instructions, refer to TD-000050 "Rear Rack Ears Installation Guide" which can be found on the QSC Website (www.qsc.com)



CAUTION! Be sure that nothing is blocking the front or rear ventilation openings, and that each side has a minimum of 2 cm clearance.

Wire Preparation

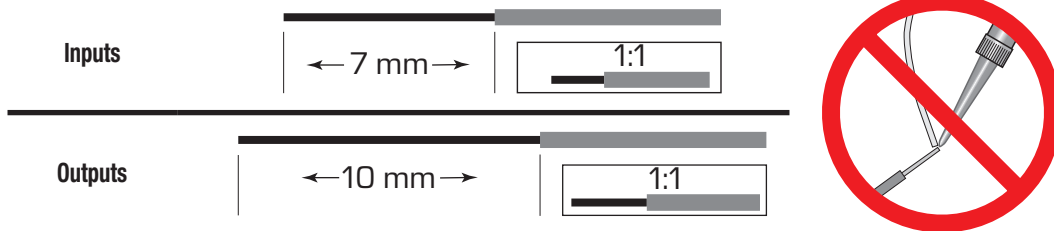

— Figure 2 —

Use an appropriate wire-stripping tool to remove 7 mm of insulation from Input wiring and 10 mm of insulation from the Output wiring. Do not tin the stripped wire ends.

Inputs

Connect the amplifier LAN A, and if available, LAN B, to the Q-LAN network (Figure 5). Refer to your Q-SYS documentation for network requirements and connection detail.

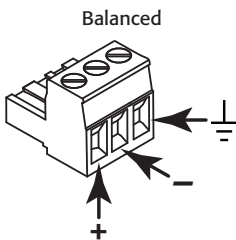

— Figure 3 —

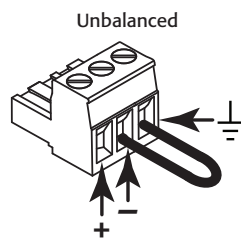

— Figure 4 —

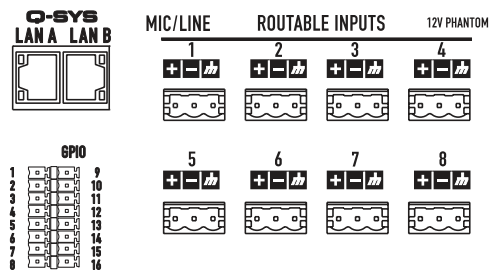

— Figure 5 —

The analog inputs are converted to digital audio in the DPA-Q amplifiers then routed to the Q-SYS Core over the Q-LAN network. The digital signals show up in Q-SYS Designer at the DPA input component where they can be routed as needed. Refer to the Q-SYS documentation.

1. Make sure your audio source devices are powered off.
2. Wire the audio mic- or line-level source to up to eight (DPA-Q 8-Channel) or up to four (DPA-Q 4-Channel) Euro-style connectors (supplied), you can use either balanced inputs (Figure 3) or unbalanced inputs (Figure 4).
3. Plug the connectors into the appropriate receptacles (Routable Inputs 1, 2, 3, 4, 5, 6, 7, 8) Figure 5 and Figure 6.

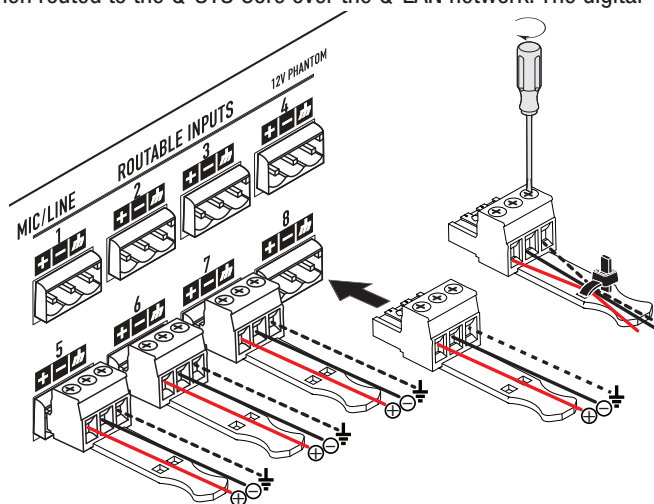

— Figure 6 —

GPIO

Refer to "[GPIO](#)" on page 16 for details about the GPIO feature.

Outputs and Output Configuration

The DPA-Q and DPA-Qn amplifiers have one or two sets of four-channel outputs that are configured independently. The configuration of the amplifier is defined in Q-SYS designer software and is "pushed" into the physical amplifier when the Name and Type of amplifier in the design matches the Name and Type of physical amplifier. Flexible Amplifier Summing Technology (FAST) allows users to power a variety of loads through combining amplifier channels in various ways. Amplifier channels can be combined in BTL Bridged mode for higher voltage needs or Parallel Mode for higher current needs. Figure 7 thru Figure 10 are examples of how the 4 channel amplifier blocks can be combined to drive higher power requirements under different loads. Please reference the power output ratings for more information.



NOTE: The output connector is capable of handling up to 8 AWG for stranded wire.

Use the diagrams shown in Figure 7 thru Figure 10 as a reference for planning your loudspeaker configuration. Refer to Figure 11 for how to connect the wiring based on your configuration.



CAUTION! Before turning the amplifier on, double check your output connections to be sure they are connected properly based on the output configuration specified in Q-SYS Designer. If you change the output configuration of the amplifier you must change the loudspeaker connections before applying power to the amplifier! After a change of the output configuration, the amplifier re-boots and all outputs are muted. You must press the Mute All button in the Q-SYS Amp Output component, Press The Amplifier Mode Button on the front panel of the amplifier.

Figure 7 through Figure 10 are examples of the three types of output configurations: Separate, Bridged and Parallel. The tables to the right and left of the loudspeaker connections (rear panel of the amplifier) give all the possible configurations and their connections. The following diagrams show the 8-Channel models. 4-Channel models have outputs A through D only.

A B C D 4 Channel | **E F G H 4 Channel**

Separate Channels (A B C D) and (E F G H)

For Separate Loudspeakers

Use eight 2-wire cables, connect to:

- T1+/T2- (Loudspeaker A / E)
- T3+/T4- (Loudspeaker B / F)
- T5+/T6- (Loudspeaker C / G)
- T7+/T8- (Loudspeaker D / H)

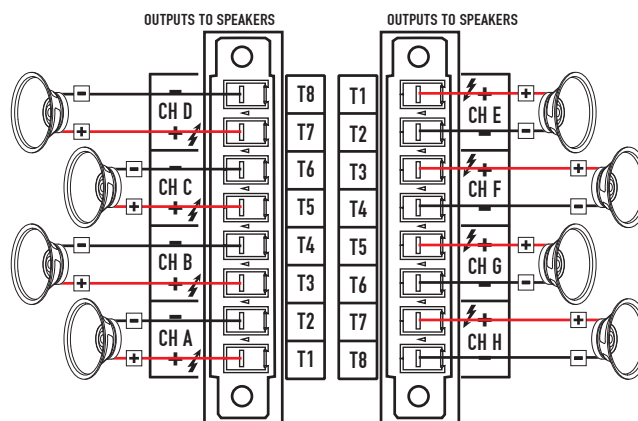
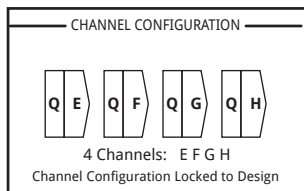
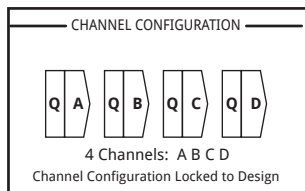

— Figure 7 —

A+B C D 3 Channel, A B Bridged | **E F G H 4 Channel**

Bridged (A+B) and Separate (C D) and (E F G H) Channels

For A+B (Bridged) One Loudspeaker

Use one 2-wire cable connect to:

- T1+/T3- (Loudspeaker A+B)

For C D (E F G H) (Separate) Two and Four Loudspeakers

Use six 2-wire cables, connect to:

- T1+/T2- (Loudspeaker E)
- T3+/T4- (Loudspeaker F)
- T5+/T6- (Loudspeaker C / G)
- T7+/T8- (Loudspeaker D / H)

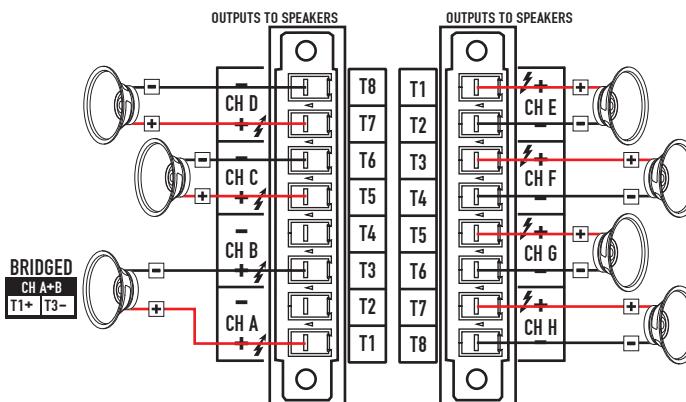
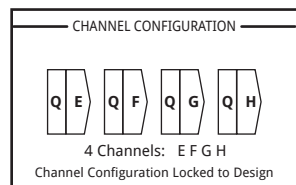
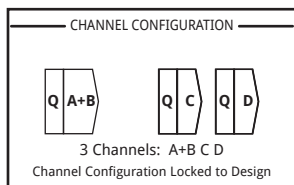

— Figure 8 —

AB CD 2 Channel, AB Parallel CD Parallel | **EF + GH 1 Channel, EF Parallel Bridged with GH Parallel**

Two Pair of Parallel Channels (AB CD) and two Pair of Parallel Channels Bridged (EF + GH)

AB (Parallel) CD (Parallel) For Two Loudspeakers

Use two 2-wire cables, connect to:

- T1+/T2- (Loudspeaker AB)
- T5+/T6- (Loudspeaker CD)

EF (Parallel) Bridged with GH (Parallel) For One Loudspeaker

Full power to one loudspeaker

Use one 2-wire cable, connect to:

- T1+/T5- (Loudspeaker EF+GH)

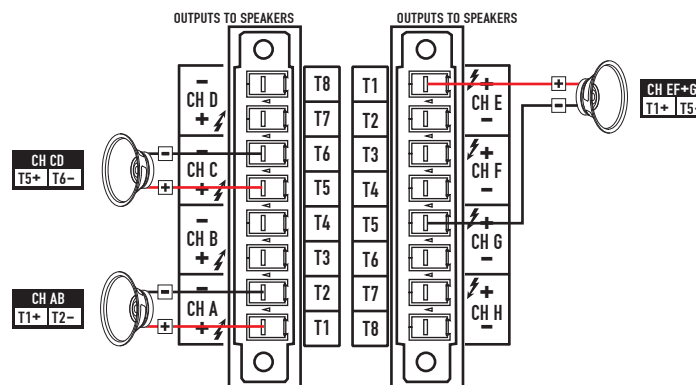
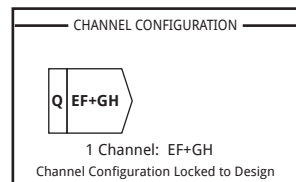
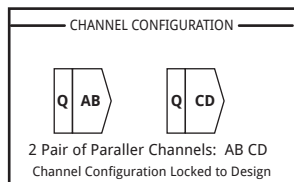

— Figure 9 —

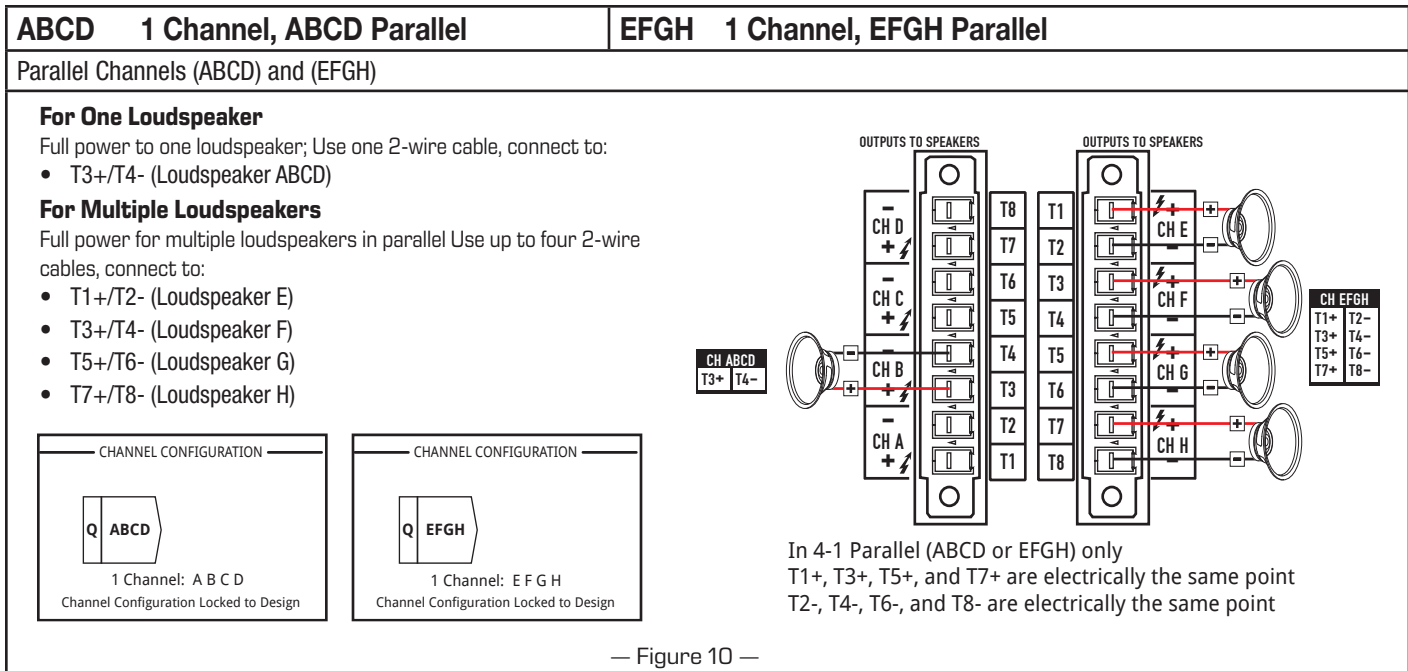

Possible Combinations

The table below lists the options available in Q-SYS Designer.

Outputs	Configuration / Channels	Outputs	Configuration / Channels
A B C D	4 Channel	E F G H	4 Channel
A+B C D	3 Channel, A B Bridged	E+F G H	3 Channel, E F Bridged
A+B C+D	2 Channel, A B Bridged C D Bridged	E+F G+H	2 Channel, E F Bridged G H Bridged
AB C D	3 Channel, A B Parallel	EF G H	3 Channel, E F Parallel
AB C+D	2 Channel, A B Parallel C D Bridged	EF G+H	2 Channel, E F Parallel G H Bridged
AB CD	2 Channel A B Parallel C D Parallel	EF GH	2 Channel E F Parallel G H Parallel
AB+CD	1 Channel, A B Parallel Bridged with C D Parallel	EF+GH	1 Channel, E F Parallel Bridged with G H Parallel
ABC D	2 Channel A B G Parallel	EFG H	2 Channel E F G Parallel
ABCD	1 Channel A B C D Parallel	EFGH	1 Channel E F G H Parallel

A B = Individual Channels, AB = Parallel Channels, A+B = Bridged Channels

Connect the Loudspeakers



WARNING! There is a potential of having dangerous voltage at the output terminals on the rear of the amplifier. Use caution not to touch these contacts. Make sure the Power switch is off prior to making any connections.



NOTE: The output connector is capable of handling up to 8 AWG for stranded wire.

1. Connect the loudspeaker wiring to the 8-pin Euro-style connector as needed for your amplifier's configuration.
2. Install the female 8-pin Euro-style connector onto the male connector on the rear of the amplifier as shown in Figure 11.
3. Use a Phillips screwdriver to secure the connector.



IMPORTANT! The DPA-Q series of audio power amplifiers are high power amplifiers designed for installation use in both Lo-Z and Hi-Z applications. Proper wiring class/size is required to ensure safe operation. Based on operating mode, these amplifiers are designed for use with the following speaker wiring:

- FAST Channel Configuration Mode: Single Channel & Parallel = Class 2 wiring

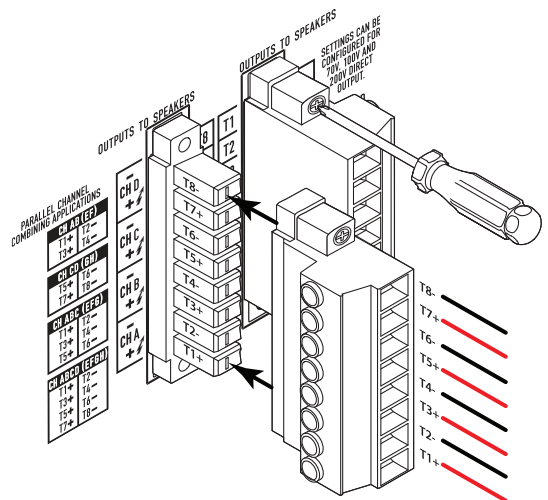

— Figure 11 —

AC Mains



WARNING! When the AC Power is on, there is a potential of having dangerous voltage at the output terminals on the rear of the amplifier. Use caution not to touch these contacts. Turn off the Power switch prior to making any connections.

1. Make sure the Power switch on the rear of the amplifier is off.
2. Connect the IEC power cord to the AC receptacle. (Figure 12)

AC Power On

After connecting the outputs to the loudspeakers, you may turn the amplifier on.

1. Make sure the output gain settings for all audio-source devices (CD Players, Mixers, Instruments, etc.) are at the lowest output (max attenuation).
2. Turn on all audio sources.
3. Turn the power switch, on the back of the amplifier, to ON. The amplifier starts in the state it was in when power was removed. If the amplifier is in Standby or Mute All mode (Amplifier Mode button LED solid red or blinking), press the Amplifier Mode button to change the amplifier to Run mode. Refer to ["Amplifier Modes" on page 11](#) for information on Modes.
4. You can now bring up the outputs of your audio sources.

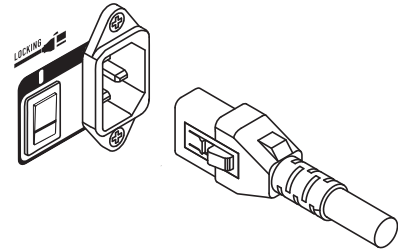

— Figure 12 —

Amplifier Controls and Indicators

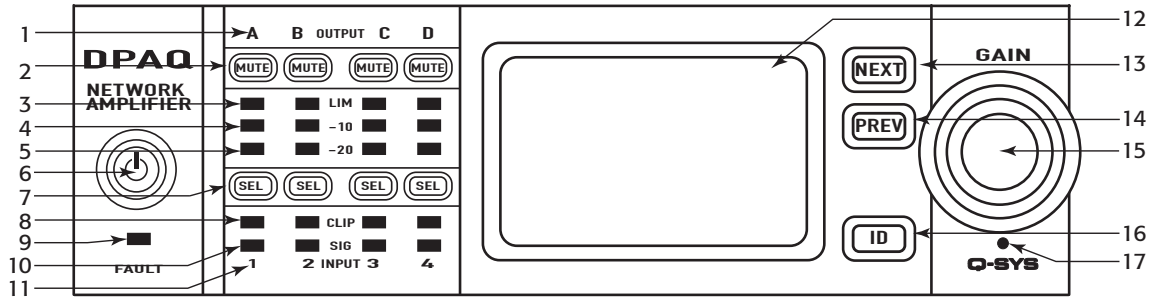

— Figure 13 — DPA-Q 8-Channel Shown

- | | | |
|--|---|-------------------------|
| 1. Output Channel labels A, B, C, D, E, F, G, H | 6. Amplifier Mode button (Green/Red) | 12. LCD Graphic Display |
| 2. Output Channel Mute buttons / LEDs (Red) | 7. Output Channel Select buttons / LEDs (Blue) | 13. NEXT button |
| 3. Output Channel Limiter LEDs (Red) | 8. Input Channel Clip LEDs (Red) | 14. PREV button |
| 4. Output Channel -10 dB below maximum amplifier output (Blue) | 9. FAULT LED (Amber) | 15. GAIN Knob |
| 5. Output Channel -20 dB below maximum amplifier output (Blue) | 10. Input Channel Signal-Present LEDs (Blue) | 16. ID button |
| | 11. Input Channel labels 1, 2, 3, 4, 5, 6, 7, 8 | 17. Pinhole Reset |



NOTE: The following scenarios assume that the amplifier is connected to the Q-SYS Core via Q-LAN. *When the amplifier is not connected to the Q-SYS Core, it is in a Fault mode, and not operational unless previously configured for fail-over or standalone mode as part of a Q-SYS design.*

With the exception of the Power Switch, found on the rear panel, all of the following controls are on the front panel. Refer to Figure 13 for location of front-panel controls.

Amplifier Modes

Off Mode

- Rear-panel power switch is off, the amplifier is not operable.
- The Amplifier Mode button (6) is not illuminated.
- Turn the power switch to ON. The amplifier enters the mode in which it was when power was removed – Run, Mute All, or Standby.

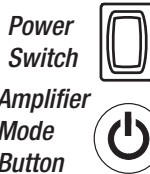

Run Mode

- From Standby or Mute All mode, press and release the Amplifier Mode button on the front panel. The amplifier is in Run Mode.
- The Amplifier Mode button (6) is illuminated green.
- The amplifier is fully operable; audio can pass.



Standby Mode

- From Mute All or Run mode, press and hold the Amplifier Mode button (6) on the front panel for approximately four seconds.
- The Amplifier Mode button illuminates solid red.
- The amplifier is not operable; audio will not pass.



Mute All Mode

- From the Run Mode, quickly press and release the Amplifier Mode button (6).
- The Amplifier Mode button flashes red, all output Mute buttons (2) are red.
- The amplifier output is disabled, but the front panel is fully operable.



Controls

SEL Buttons (7)

- Output Channel gain can be adjusted from the Q-SYS Designer software or from the front panel of the amplifier.
- Use the SEL button to select one or more than one channel to change gain settings. All selected channels will change at the same time.



- If two or more outputs are bridged or in parallel, pressing one button in the group selects all channels in that bridged or parallel group.

NEXT (13) and PREV (14) Buttons



- Navigates forward and backwards through the screens.

GAIN Knob (15)



- Adjusts the Gain for the selected output channel or channels. At least one channel must be selected.
- When one or more channels are selected, turn the Gain knob to jump to the Output Gains screen. After a few seconds with no activity, it returns to the earlier screen.
- If there is more than one channel selected, and the gains for those channels are different, the difference is maintained unless the gain is raised or lowered to the limits for both channels.

ID Button (16)



- Press this button to display a screen with the amplifier's network name. In addition, the ID buttons on the associated Q-SYS Amplifier component and the associated Q-SYS Configurator item flashes. Press again, or click one of the other ID buttons, to stop the flashing and exit the screen.

Pinhole Reset (17)



- Resets the amplifier to its factory default settings.
1. Insert a paper clip or similar tool into the pinhole
 2. Press and hold for 3 seconds.
 3. Press the ID button to confirm and reset the amplifier.
- Items reset include:
- Network settings set to Auto,
 - Amplifier name set to default,
 - Password deleted, and
 - Log file deleted.

Input and Output Signal Flow

DPA-Q Series Amplifiers

Refer to Figure 14

The DPA 4K8Q and DPA 8K8Q amplifiers have eight MIC/LINE inputs and eight (two blocks of four) amplified outputs on the rear of the amplifier. The DPA 2K4Q, DPA 4K4Q, and DPA 8K4Q amplifiers have four MIC/LINE inputs and four (one block of four) amplified outputs on the rear of the amplifier. The inputs and outputs are not physically (or electrically) connected in the amplifier giving you the flexibility to use any available source in Q-SYS for the amplified outputs, and to route the inputs to any output. The inputs and outputs can be connected in your Q-SYS design as shown in Figure 14.

1. The analog inputs are converted to digital audio in the amplifier
2. The converted audio is then routed to the Q-SYS Core via Q-LAN (LAN A, LAN B).
3. The digital signals are brought into the design via the amplifier's Mic/Line Input component.
4. From the Mic/Line Input component the signals can be sent for processing and can be sent anywhere within the Q-SYS system.
5. In the Q-SYS Core digital audio signals (not necessarily from the amp's inputs) are sent to the Q-SYS Amp Output component.
6. The digital audio is then sent from the Q-SYS Core via Q-LAN to the amplifier.
7. Digital signals are converted to analog, amplified and sent to outputs of the amplifier.

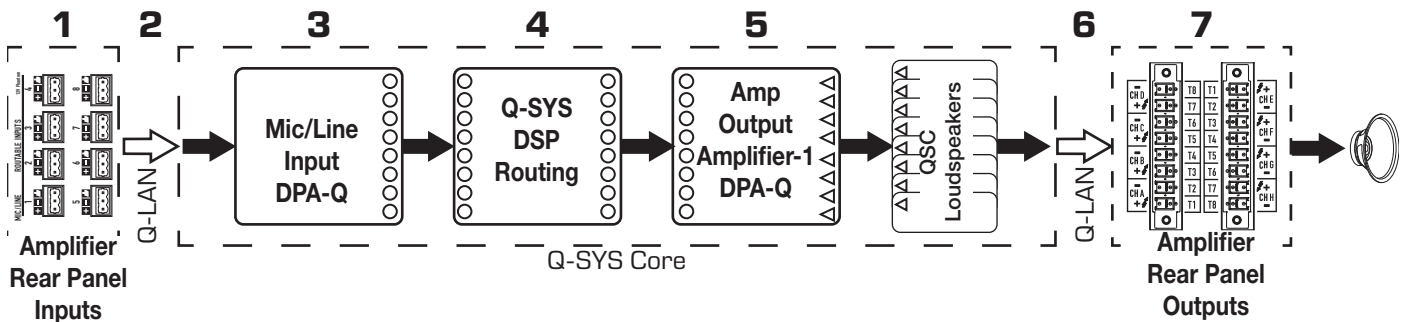

— Figure 14 — 8-Channel Model Shown

The Q-SYS Amp Output component can have one to eight inputs/outputs depending on the amplifier model and its configuration in Q-SYS Designer. The desired configuration is selected in the Q-SYS Designer Properties menu for the amplifier. When the amplifier's configuration is changed, all of the outputs are placed in a "mute all" state. You can un-mute all by clicking the Mute All button in Q-SYS Designer's Amp Output component or press and release the Amplifier Mode button on the amplifier's front panel.

DPA-QN Series Amplifiers

Refer to Figure 15

The DPA-QN model amplifiers have no analog inputs. The input signal utilized to drive the amplifier channels must be virtually wired in Q-SYS Designer.

1. Digital audio is sent to the Q-SYS Core via Q-LAN.
2. In the Core, the signals can be processed and sent anywhere within the Q-SYS system.
3. In the Q-SYS Core digital audio signals are sent to the Q-SYS Amp Output component.
4. The digital audio is then sent from the Q-SYS Core via Q-LAN to the amplifier.
5. Digital signals are converted to analog, amplified, and sent to the outputs of the amplifier.

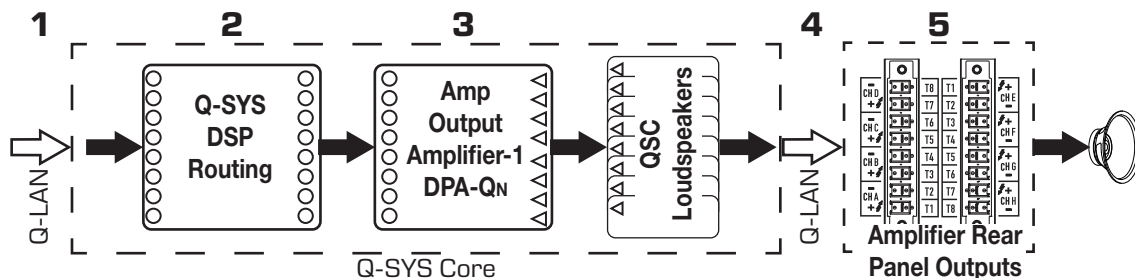

— Figure 15 — 8-Channel Model Shown

The Q-SYS Amp Output component can have one to eight inputs/outputs depending on the amplifier model and its configuration in Q-SYS Designer. The desired configuration is selected in the Q-SYS Designer Properties menu for the amplifier. When the amplifier's output configuration is changed, all of the outputs are placed in a "mute all" state. You must unmute all in the Amp Output component's control panel or on the amplifier's front panel.

Screens

STATUS Screen

Refer to Figure 16

- DEVICE** – the hostname (network name) of the amplifier. A default name is given at the factory, similar to the example. You may change the name in the Q-SYS Configurator.
- DESIGN** – the name of the Q-SYS design currently running on the amplifier. The amplifier must be contained in a running design to operate.
- STATUS** – displays the current status of the amplifier both in text and color. The following is a list of possible status colors, and some example conditions.
 - OK** – green – audio is good, hardware is good.
 - Compromised** – orange – audio is good but a redundancy mechanism is active (one LAN down but the other is still up) or a non-fatal hardware problem exists (fan speed, high temperature, low AC voltage, output load, amplifier is in Protect mode, etc.)
 - Fault** – red – audio is not passing, or hardware is malfunctioning or mis-configured (amplifier power off, audio streams broken, amplifier fault, loudspeaker short circuit, etc.)
 - Initializing** – blue – In the process of initialization, and design start. Audio cannot pass.
- FIRMWARE** – the Q-SYS Designer firmware version installed on the amplifier.

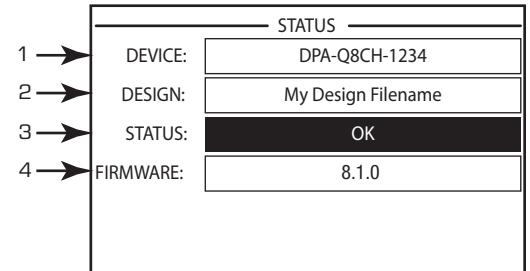

— Figure 16 —



NOTE: The DPA-Q 4- and 8-channel amplifiers require Version 8.1.0 or later of Q-SYS Designer.

To Update the Amplifier Firmware:

- Install the version of Q-SYS Designer you want to use on your PC.
- The amplifier must be connected to Q-LAN and turned on.
- Open the Q-SYS design containing the amplifier in the Designer version you just installed.
- Select "Save to Core and Run" from the File menu.
- The amplifier and any other Q-SYS peripherals in the design are automatically updated.

LAN A / LAN B Screen

Refer to Figure 17

- IP ADDRESS** – a default address is assigned in the factory. You can change this and the other parameters in Q-SYS Configurator. LAN A is required, and cannot be turned off.
- NETMASK** – must be the same as the Core's Netmask.
- GATEWAY** – must be the same as the Core's Gateway.
- LAN B** is not required. When connected, the same type of information as LAN A is displayed.

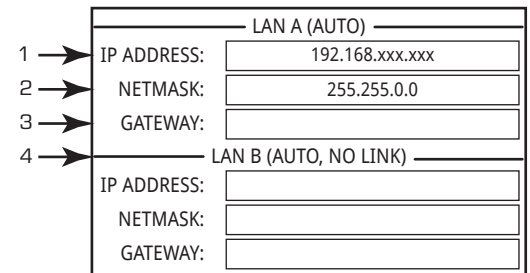

— Figure 17 —

HEALTH Screen

Refer to Figure 18

- FAN RPM** – varies depending on the temperature.
- PSU TEMP** – varies depending on operating conditions. PSU Temp is monitored and can automatically put the amp into limiting or shutdown if safe operating temperatures are exceeded.
- AC VOLTAGE** – AC Mains voltage
- AC CURRENT** – AC mains current drawn by the amplifier.
- Voltage Rails
 - V RAIL 1** = +147VDC +/- 5V typical
 - V RAIL 2** = -147VDC +/- 5V typical

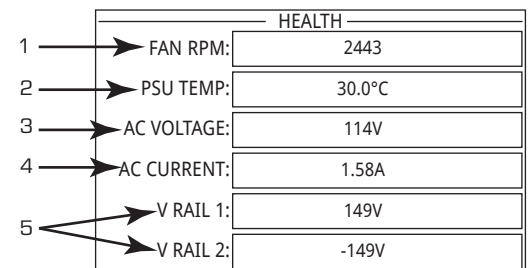

— Figure 18 —

STANDALONE OUTPUT GAINS Screen

Refer to Figure 19

The STANDALONE OUTPUT GAINS screens provide a quick overview of all outputs. In addition, when this screen is displayed, you can make gain adjustments from the amplifier's front panel. There is one screen for channels A–D and one for channels E–H.

Use the NEXT or PREV buttons to access these screens, or press one or more of the SEL buttons to access the screen.

1. The highlighted background indicates that the Channel is selected by the SEL button.
2. **Channel** – the channels display according to the configuration of the amplifier.
3. **Output Gain** – the output gain can be controlled in two places: the GAIN knob on the amplifier front panel and with the Gain control in the amplifier's Output component in the Q-SYS design.
4. **Q-LAN** Input Level – the level of the audio signal applied to the Output component in the Q-SYS design. The DPA-Q Output component is the connection to the output section of the amplifier.
5. **VOLTS** – the voltage applied to that output.
6. In the example Output B is combined with Output A – (AB or A+B), the slot for Output B is blank.

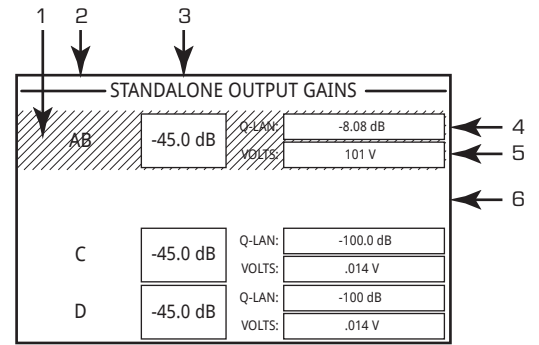

— Figure 19 —

To Make Gain Adjustments:

- a. Use the SEL button to select one or more output channels. You can select any or all channels.
- b. Use the GAIN knob to make adjustments to the output gain of the selected channels.



NOTE: If the gains were the same when you select multiple channels the gains remain equal as you adjust them. If the gains are different, they keep their relative separation until one reaches a limit. At this point the other channel(s) continue to change until they reach the limit.



NOTE: If you press one or more of the SEL buttons, and do not make any GAIN adjustments, this screen remains visible for a short time then returns to the previous screen.

OUTPUT Screens

Each block of four outputs has a dedicated screen. Figure 20 is an example of Outputs A – D.

1. Output channel identifiers **A – D and E – H** (not shown).
2. **DAC** – when illuminated, this indicates that the signal to the D to A Converter is larger than can be reproduced and a limiter has been engaged to prevent clipping.
3. **PROTECT** – when illuminated, this indicates that the amplifier is in Protect Mode. Conditions can include over current, excessive long term average power output, impedance too low.
4. **LIMIT** – when illuminated, this indicates the amplifier limiter is active. There are five conditions that could cause the LIMIT condition:
 - Power
 - Current
 - Voltage
 - Temperature
 - Loudspeaker Protection is active.
5. **SHORT** – when illuminated, this indicates the output is shorted. A short can be triggered by either of the following:
 - a. Output impedance is below $\frac{1}{4} \Omega$ for more than 1 second.
 - b. Output voltage is less than 50% of what the DSP was expecting for more than 1 second.
6. Displays the temperature, in Centigrade, of the associated channel.

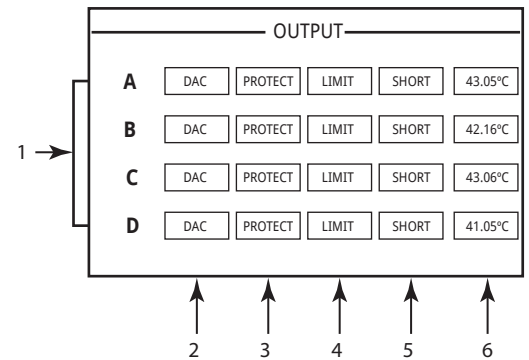

— Figure 20 —

CHANNEL CONFIGURATION Screens

1. Figure 21 is a graphic representation of the amplifier's output CHANNEL CONFIGURATION. Inputs (Q) are from Q-SYS, outputs A–D (E–H not shown) represent the amplifier output channels and their configuration.
2. Text indicating how many channels, and the output configuration. For possible configurations refer to "[Possible Combinations](#)" on page 9 or, the Q-SYS help for the amplifier components.
3. Status of the amplifier and Q-SYS design indicating the design and amp are in sync.

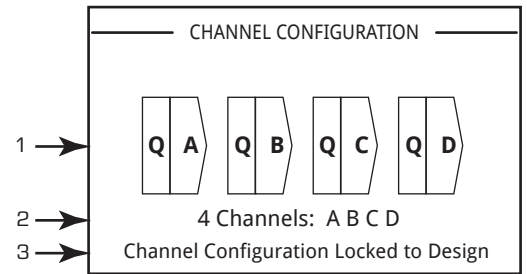

— Figure 21 —

ROUTABLE MIC/LINE INPUTS

This screen is not available on the DPA-QN model amplifiers.

Figure 22 shows the Routable MIC/LINE INPUTS screen for channels 1–4, (channels 5–8 not shown) which displays the status of the physical MIC/LINE INPUTS for the Q models.

1. Input channels are identified numerically, 1–4 (and 5–8 not shown)
2. **Input Level** – is the Peak Input Level (dBFS) and is the same as displayed in the Q-SYS Mic/Line Input component.
3. **Muted** – when illuminated indicates that the Input is muted for the associated channel. This is controlled by the Mute button on the Q-SYS Designer Mic/Line Input component. *Input channels cannot be muted from the amplifier interface.*
4. **Clip** – indicators illuminate when the input to the Mic/Line Input component is too high. Adjust the Preamp Gain on the Mic/Line Input component in Q-SYS Designer.
5. **P12** – phantom power (+12V) is available for microphones (condenser) requiring power. You can turn the phantom power on/off in the Mic/Line Input component in Q-SYS Designer.

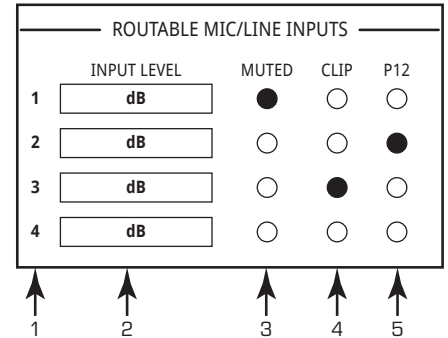

— Figure 22 —

GPIO

There are 16 General Purpose Input Output pins for use in various applications. Figure 23 shows the pin configuration for the connector on the rear of the amplifier. — Table 2 shows the connector pin-out. Figure 24 gives some simple GPIO applications.

— Table 2 —

Connector Pin	GPIO # and Function	Specifications
1	3.3 V	100 mA max (power cycle to reset current limiting)
2	GPIO 1	5mA in/out, 3.3V max, 127Ω resistor in series
3	GPIO 2	5mA in/out, 3.3V max, 127Ω resistor in series
4	GND	Ground
5	GPIO 3	5mA in/out, 3.3V max, 127Ω resistor in series
6	GPIO 4	5mA in/out, 3.3V max, 127Ω resistor in series
7	GND	Ground
8	GPIO 5	18mA in/out max, 3.3V max, 127Ω resistor in series
9	RELAY NO ¹	Relay Normally Open
10	RELAY COM ¹	Relay Common
11	RELAY NC ¹	Relay Normally Closed
12	GND	Ground
13	GPIO 6	18mA in/out max, 3.3V max, 127Ω resistor in series
14	GPIO 7	18mA in/out max, 3.3V max, 127Ω resistor in series
15	GND	Ground
16	GPIO 8	18mA in/out max, 3.3V max, 127Ω resistor in series

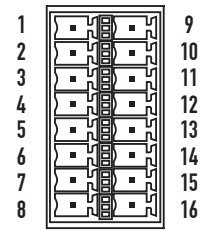

— Figure 23 —

¹ Nominal switching capacity is 30 VDC at 2 A for a total of 60 W maximum. The maximum voltage is 220 VDC if the current is limited to observe the maximum power rating (60 W).

Examples

Button or Contact Closure

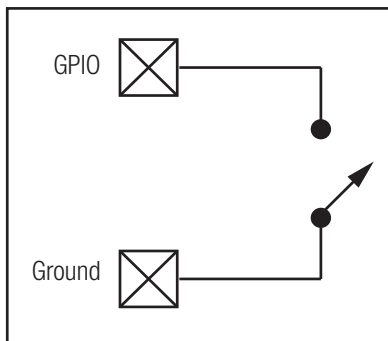

Potentiometer

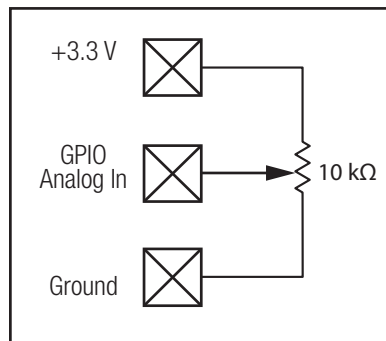

Q-SYS-Powered LED

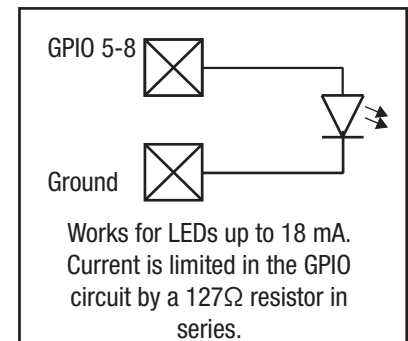

— Figure 24 —

Specifications ¹

Power Specifications – 4-Channel Models

Configuration	Loads	DPA 2K4Q / DPA 2K4QN		DPA 4K4Q / DPA 4K4QN		DPA 8K4Q / DPA 8K4QN	
		Max Power ²	Continuous Power	Max Power ²	Continuous Power	Max Power ²	Continuous Power
4 Independent Channels A, B, C, D	16 Ω	350	200	500	313	625	625
	8 Ω	700	400	1000	625	1250	1250
	4 Ω	800	400	1500	625	2400	1250
	2 Ω	600	300	800	400	2750	1250
2 Channels Combined in Parallel AB or CD Doubles Current	8 Ω	800	400	1000	625	1250	1250
	4 Ω	1250	750	2000	1250	2400	2250
	2 Ω	1500	650	2500	1250	4000	2100
3 Channel Combined in Parallel ABC Triples Current	8 Ω	800	400	1000	1000	1250	1250
	4 Ω	1250	800	2000	2000	2400	2400
	2 Ω	1500	1100	3000	2500	4500	3000
2 Channels Combined in BTL Bridged A+B or C+D Doubles Voltage	8 Ω	1500	700	3000	1250	4000	2250
	4 Ω	1400	600	1700	1150	5000	2500
	2 Ω	N/R ³	N/R ³	N/R ³	N/R ³	3000	2000
4 Channels Combined in Bridged/Parallel AB+CD Doubles Current & Voltage	8 Ω	2500	1500	3500	2500	4200	4200
	4 Ω	3000	1600	4000	2500	7000	4500
	2 Ω	N/R ³	N/R ³	N/R ³	N/R ³	8000	4000
4 Channels Combined in Parallel ABCD Quadruples Current	8 Ω	800	400	1000	1000	1250	1250
	4 Ω	1250	800	2000	1600	2500	2400
	2 Ω	1700	1600	4000	2500	5000	4500
	1 Ω	2500	1500	4000	2000	7000	4500

¹ Specifications are subject to change without notice.

² Max Power

- » Max Power data is based on the most potential any single amplifier channel can deliver. This data is most useful for asymmetrical loading of amplifier channel and maximizing power utilization of the amplifier. When utilizing FlexAmp™ power requirements, be sure to take into consideration the power capabilities of the channel AND the capabilities of the Power Supply.
- » Continuous Power indicates amplifier output capabilities with all channels driven with the same load without exceeding the capabilities of the power supply.
- » Power Spec is based on 1 kHz, 20 msec

³ N/R = Not Recommended

Power Specifications ¹ – 8-Channel

Configuration	Loads	DPA 4K8Q / DPA 4K8QN		DPA 8K8Q / DPA 8K8QN	
		Maximum Power ²	Continuous Power	Maximum Power ²	Continuous Power
4 or 8 Independent Channels A, B, C, D, E, F, G, H	16 Ω	500	150	625	300
	8 Ω	1000	300	1250	600
	4 Ω	1000	300	1500	600
	2 Ω	800	300	1000	300
2 Channels Combined in Parallel AB or CD or EF or GH Doubles Current	8 Ω	1000	600	1250	1100
	4 Ω	1250	600	2400	1200
	2 Ω	1500	600	2500	600
3 Channel Combined in Parallel ABC or EFG Triples Current	8 Ω	1000	900	1250	1100
	4 Ω	1500	900	2000	1800
	2 Ω	1500	900	2500	1800
2 Channels Combined in BTL Bridged A+B or C+D or E+F or G+H Doubles Voltage	8 Ω	1500	600	3000	1200
	4 Ω	1400	400	1700	600
	2 Ω	N/R ³		N/R ³	
4 Channels Combined in Bridged/Parallel AB+CD, EF+GH Doubles Current & Voltage	8 Ω	2500	1200	4000	2400
	4 Ω	3000	1200	5000	2400
	2 Ω	N/R ³		N/R ³	
4 Channels Combined in Parallel ABCD or EFGH Quadruples Current	8 Ω	1000	1000	1200	1200
	4 Ω	2000	1200	2400	2200
	2 Ω	2500	1200	4000	2400
	1 Ω	3000	1200	4000	2400

¹ Specifications are subject to change without notice.

² Max Power

» Max Power data is based on the most potential any single amplifier channel can deliver. This data is most useful for asymmetrical loading of amplifier channel and maximizing power utilization of the amplifier. When utilizing FlexAmp™ power requirements, be sure to take into consideration the power capabilities of the channel AND the capabilities of the Power Supply.

» Continuous Power indicates amplifier output capabilities with all channels driven with the same load without exceeding the capabilities of the power supply.

» Power Spec is based on 1 kHz, 20 msec

³ N/R = Not Recommended

Peak Voltage Specifications – 4-Channel Models

Configuration	Loads	DPA 2K4Q / DPA 2K4QN		DPA 4K4Q / DPA 4K4QN		DPA 8K4Q / DPA 8K4QN	
		Max Peak Voltage	Max Peak Current	Max Peak Voltage	Max Peak Current	Max Peak Voltage	Max Peak Current
Independent Channels (SE) A, B, C, D	16 Ω	N/A	N/A	N/A	N/A	N/A	N/A
	8 Ω	106	13.2	126	15.8	141	17.6
	4 Ω	80	20.0	110	27.4	139	34.6
	2 Ω	49	24.0	57	28.3	105	52.4
Parallel Channels (x2) AB or CD Doubles Current	8 Ω	N/A	N/A	N/A	N/A	N/A	N/A
	4 Ω	N/A	N/A	N/A	N/A	N/A	N/A
	2 Ω	N/A	N/A	N/A	N/A	N/A	N/A
BTL/Bridged Channels (x2) A+B or C+D Doubles Voltage	8 Ω	155	19.4	179	22.4	253	31.6
	4 Ω	106	26.5	117	29.2	200	50
	2 Ω	N/R		N/R		110	54.8

N/R = Not Recommended
N/A = Not Available
Gray cells = mode or rating n/a

NOTE: Data indicates the maximum voltage and current potential for any amplifier single amplifier channel. The data in the table above has been measured for these specific conditions. N/A indicates data is not available. NR indicates that this configuration is not recommended.

Peak Voltage Specifications – 8-Channel Models

Configuration	Loads	DPA 4K8Q / DPA 4K8QN		DPA 8K8Q / DPA 8K8QN	
		Max Peak Voltage	Max Peak Current	Max Peak Voltage	Max Peak Current
Independent Channels (SE) A, B, C, D, E, F, G, H	16 Ω	N/A	N/A	N/A	N/A
	8 Ω	126	11.2	141	12.5
	4 Ω	89	15.8	110	19.4
	2 Ω	57	20	63	22.4
Parallel Channels (x2) AB or CD or EF or GH Doubles Current	8 Ω	126	11.2	141	12.5
	4 Ω	100	17.7	139	24.5
	2 Ω	77	27.4	100	35.4
BTL/Bridged Channels (x2) A+B or C+D or E+F or G+H Doubles Voltage	8 Ω	155	13.7	219	22.4
	4 Ω	106	18.7	117	20.6
	2 Ω	N/R		N/R	

N/R = Not Recommended
N/A = Not Available
Gray cells = mode or rating n/a

NOTE: Data indicates the maximum voltage and current potential for any amplifier single amplifier channel. The data in the table above has been measured for these specific conditions. N/A indicates data is not available. NR indicates that this configuration is not recommended.

Operating Specifications

	DPA 2K4Q / DPA 2K4QN	DPA 4K4Q / DPA 4K4QN	DPA 8K4Q / DPA 8K4QN	DPA 4K8Q / DPA 4K8QN	DPA 8K8Q / DPA 8K8QN
Typical Distortion					
8Ω	0.02 - 0.05%	0.02 - 0.05%	0.02 - 0.05%	0.02 - 0.05%	0.02 - 0.05%
4Ω	0.04 - 0.1%	0.04 - 0.1%	0.04 - 0.1%	0.04 - 0.1%	0.04 - 0.1%
Maximum Distortion					
4 Ω - 8 Ω	1.0%	1.0%	1.0%	1.0%	1.0%
Frequency Response (8 Ω)	20 Hz - 20 kHz +0.2 dB / -0.7 dB	20 Hz - 20 kHz +0.2 dB / -0.7 dB	20 Hz - 20 kHz +0.2 dB / -0.7 dB	20 Hz - 20 kHz +0.2 dB / -0.7 dB	20 Hz - 20 kHz +0.2 dB / -0.7 dB
Noise					
Unweighted output unmuted	>102 dB	>102 dB	>102 dB	>101 dB	>101 dB
Weighted output muted	>106 dB	>106 dB	>106 dB	>104 dB	>104 dB
Gain (1.2 V setting)	33 dB	35 dB	38 dB	35 dB	38 dB
Damping factor	>100	>100	>150	>100	>100
Input impedance	>8k balanced and >4k unbalanced	>8k balanced and >4k unbalanced	>8k balanced and >4k unbalanced	>8k balanced and >4k unbalanced	>8k balanced and >4k unbalanced
Input Sensitivity					
Continuously variable:					
Vrms	1.23 mV to 17.35 V	1.23 mV to 17.35 V	1.23 mV to 17.35 V	1.23 mV to 17.35 V	1.23 mV to 17.35 V
dBu	-56 to 27	-56 to 27	-56 to 27	-56 to 27	-56 to 27
dBv	-58.2 to 24.8	-58.2 to 24.8	-58.2 to 24.8	-58.2 to 24.8	-58.2 to 24.8
Controls and indicators (front)	Power Mode • Channel MUTE buttons • Channel SELECT buttons • Channel Input Signal and CLIP LED Indicators Channel Output and LIMIT LED meters • NEXT, PREV, ID buttons • Control knob • Color Display • Fault Indicator • Pinhole Reset				
Controls and indicators (rear)	AC Power Disconnect (Locking IEC C-14) AC Power Switch				
Input connectors					
DPA-Q	3-pin Euro (green) and Q-LAN Network connectivity				
DPA-QN	Q-LAN Network connectivity				
Output connectors	8-pin Euro (green)				
GPIO	GPIO 1-8 = configurable digital/analog, input/output Relay max = 30 VDC at 1 A (30W maximum). Max voltage 220 VDC at 136 mA. 3.3 V 100 mA max (power cycle to reset) GPIO 1-4 max = 5 mA in/out, 3.3 V, 127 Ω series resistor GPIO 5-8 max = 18 mA in/out, 3.3V, 127 Ω series resistor				
Cooling					
Type	Forced air cooling, thermally regulated fan speed, side/rear-to-front airflow				
Operating temperature range	Maximum: -10° - 50° C, recommended: 0° - 35° C, performance may be reduced above 40° C				
Amplifier and load protection	Short circuit, open circuit, over current, over voltage, thermal, RF, DC fault shutdown, active inrush limiting, on/off muting				
AC power input	Universal power supply 100 - 240 V~ 50 / 60 Hz with Active PFC				
AC power input (China Only) 交流电源输入 (仅限中国)	100 - 240 V~ 50 / 60 Hz		220 - 240 V~ 50 / 60 Hz	100 - 240 V~ 50 / 60 Hz	220 - 240 V~ 50 / 60 Hz
Dimensions (HWD)	3.5 in x 19 in x 16 in (89 mm x 483 mm x 406 mm)				
Weight					
Net	23 lb (10.4 kg)	25 lb (11.3 kg)	26 lb (11.8 kg)	25 lb (11.3 kg)	26 lb (11.8 kg)
Shipping	27 lb (12.2 kg)	29 lb (13.2 kg)	30 lb (13.6 kg)	29 lb (13.2 kg)	30 lb (13.6 kg)
Agency approvals	UL, CE, RoHS/WEEE compliant, FCC Class B (conducted and radiated emissions)				
Carton contents	IEC power cord (locking), Quick Start Guide, Euro connectors, amplifier				

Heat Loss and Current-Draw Charts

Heat losses are the thermal emissions from an amplifier while it is operating. It comes from dissipated waste power—i.e., real AC power in minus audio power out. Measurements are provided for various loads at idle, 1/8 of average full power, 1/3 of average full power, and full power, with all channels driven simultaneously. For typical usage, use the idle and 1/8 power figures. This data is measured from representative samples; due to production tolerances, actual heat emissions may vary slightly from one unit to another. Bridged into 8 Ω is equivalent to 4 Ω per channel; into 4 Ω is equivalent to 2 Ω per channel.

Idle

Thermal loss at idle or with very low signal level.

1/8 Power

Thermal loss at 1/8 of full power is measured with a pink noise signal. It approximates operating with music or voice with light clipping and represents the amplifier's typical "clean" maximum level, without audible clipping. Use these figures for typical maximum level operation.

1/3 Power

Thermal loss at 1/3 of full power is measured with 1 kHz sine. It approximates operating with music or voice with very heavy clipping and a very compressed dynamic range.

Full Power

Thermal loss at full power is measured with a 1 kHz sine wave. However, it does not represent any real-world operating condition.

Current Draw

The amount of AC current an amplifier demands while it is operating. Measurements are provided for various loads at idle, 1/8 of average full power, 1/3 of average full power, and full power, with all channels driven simultaneously. The data shown in the following tables is listed for 100 V~, 120 V~ and 230 V~ operation. For typical usage, use the idle and 1/8 power data.

Current Consumption –



NOTE: Power Dissipation minimally varies between 100 and 240 V~. This data is based on all operating voltages (100 - 240 V~).

Model: DPA 2K4Q / DPA 2K4QN

Output Level	Load	100 V~ Current	120 V~ Mains		230 V~ Mains		Thermal Dissipation	
			AC Current (Amps)	Losses (Watts)	AC Current (Amps)	Losses (Watts)	BTU/h	kcal/h
Standby		0.5	0.5	44	0.4	40	150	38
Mute All		0.8	0.7	31	0.5	35	106	27
Idle		1.1	0.9	101	0.6	98	345	87
1/8 Rated Power (Pink Noise)	8 Ω / Channel	4.1	3.44	180	1.98	170	614	155
	4 Ω / Channel	3.9	3.25	158	1.97	193	539	136
	2 Ω / Channel	4.9	4.09	247	2.27	247	843	212
1/3 Rated Power (1kHz Sine Wave)	8 Ω / Channel	7.9	6.6	252	3.44	233	860	217
	4 Ω / Channel	8.7	7.24	316	3.75	293	1079	272
	2 Ω / Channel	9.6	7.97	405	4.11	379	1382	348

Model: DPA 4K4Q / DPA 4K4QN

Output Level	Load	100 V~ Current	120 V~ Mains		230 V~ Mains		Thermal Dissipation	
			AC Current (Amps)	Losses (Watts)	AC Current (Amps)	Losses (Watts)	BTU/h	kcal/hr
Standby		0.6	0.5	45	0.4	45	154	39
Mute All		0.8	0.7	32	0.5	36	109	28
Idle		1.1	0.9	102	0.6	100	348	88
1/8 Rated Power (Pink Noise)	8 Ω / Channel	5.3	4.4	199	2.4	191	679	171
	4 Ω / Channel	5.6	4.7	231	2.5	220	788	199
	2 Ω / Channel	6.1	5.1	288	2.7	258	983	248
1/3 Rated Power (1kHz Sine Wave)	8 Ω / Channel	11.1	9.3	291	4.8	261	993	250
	4 Ω / Channel	11.7	9.7	350	5	320	1195	301
	2 Ω / Channel	12.8	10.7	473	5.5	443	1614	407

Model: DPA 8K4Q / DPA 8K4QN

Output Level	Load	100 V~ Current	120 V~ Mains		230 V~ Mains		Thermal Dissipation	
			AC Current (Amps)	Losses (Watts)	AC Current (Amps)	Losses (Watts)	BTU/h	kcal/hr
Standby		0.8	0.7	79	0.5	83	270	68
Mute All		0.9	0.8	36	0.6	42	123	31
Idle		1.9	1.6	173	0.9	166	590	149
1/8 Rated Power (Pink Noise)	8 Ω / Channel	10.4	8.7	370	4.6	340	1263	318
	4 Ω / Channel	10.6	8.9	382	4.8	360	1304	329
	2 Ω / Channel	11.6	9.7	472	5.3	452	1611	406
1/3 Rated Power (1kHz Sine Wave)	8 Ω / Channel	21.6	18.9	533	9.2	453	1819	458
	4 Ω / Channel	22.9	19.1	623	9.7	553	2126	536
	2 Ω / Channel	24.8	20.7	828	10.5	738	2826	712

Model: DPA 4K8Q / DPA 4K8QN

Output Level	Load	100 V~ Current	120 V~ Mains		230 V~ Mains		Thermal Dissipation	
			AC Current (Amps)	Losses (Watts)	AC Current (Amps)	Losses (Watts)	BTU/h	kcal/hr
Standby		1.0	0.8	43.9	0.5	42	150	38
Mute All		1.1	0.9	44.9	0.7	49	153	39
Idle		1.9	1.6	182.0	0.9	184	621	157
1/8 Rated Power (Pink Noise)	8 Ω / Channel	5.4	4.5	455	2.2	421	529	133
	4 Ω / Channel	6.2	5.2	536	2.5	495	805	203
	2 Ω / Channel	7.4	6.2	654	3.2	553	1208	304
1/3 Rated Power (1kHz Sine Wave)	8 Ω / Channel	11.5	9.6	1047	4.5	995	843	212
	4 Ω / Channel	12.6	10.5	1223	5.0	1059	1444	364
	2 Ω / Channel	15.7	13.1	1523	6.0	1330	2468	622

Model: DPA 8K8Q / DPA 8K8QN

Output Level	Load	100 V~ Current	120 V~ Mains		230 V~ Mains		Thermal Dissipation	
			AC Current (Amps)	Losses (Watts)	AC Current (Amps)	Losses (Watts)	BTU/h	kcal/hr
Standby		1.0	0.9	46.0	0.6	42	157	40
Mute All		1.1	1.0	49.0	0.7	49	166	42
Idle		1.9	1.7	197.0	1.0	184	672	169
1/8 Rated Power (Pink Noise)	8 Ω / Channel	5.4	8.6	972	4.5	925	1229	310
	4 Ω / Channel	6.2	10.7	1148	5.1	1007	1829	461
	2 Ω / Channel	7.4	6.2	649	3.2	557	1181	298
1/3 Rated Power (1kHz Sine Wave)	8 Ω / Channel	11.5	18.2	2102	9.1	2000	1632	411
	4 Ω / Channel	12.6	22.4	2482	9.9	2122	2928	738
	2 Ω / Channel	15.7	13.5	1548	6.5	1400	2532	638



QSC, LLC

Mailing Address: 1675 MacArthur Boulevard
Costa Mesa, CA 92626-1468 U.S.
Main Number: +1.714.754.6175
World Wide Web: www.qsc.com

Sales & Marketing:

Voice: +1.714.957.7100 or
1.800.854.4079 toll free (U.S. only)
FAX: +1.714.754.6174
E-mail: info@qsc.com

Q-SYS™ Customer Support

Application Engineering and Technical Services

Monday - Friday 7 AM to 5 PM PST | +1.714.957.7150
(Excludes Holidays) | 1.800.772.2834 toll free (U.S. only)
FAX | +1.714.754.6173
Q-SYS 24/7 Emergency Support ¹ | +1.949.791.7722
| +1.888,.252.4836 (U.S./Canada)



Q-SYS™ Customer Support

Q-SYS Support E-mail

(Immediate e-mail response times not guaranteed) | qsyssupport@qsc.com

Customer Service

Mailing Address: 1675 MacArthur Blvd.
Costa Mesa, CA 92626 U.S.
E-mail: CinemaTechSupport@qsc.com

¹ Q-SYS 24/7 Support is for Emergency assistance with Q-SYS systems only. 24/7 support guarantees a call back within 30 min after a message is left. Please include, Name, Company, Call Back Number and description of the Q-SYS emergency for prompt call back. If calling during business hours please use the standard support numbers above.